

KCM Chain

On the Forefront of Integrated Technologies



Contents



KCM CHAIN - Japanese Roller Chain

Chain Components	26
Selecting Roller Chain	27
ANSI Standard Roller Chain	31
Multiple Strand Type.....	32
BS Roller Chain	33
Double Pitch Chain	34
H 'Heavy' Series Chain.....	36
HE 'Extra Heavy' Series Chain	37
Hollow Pin Chain	38
Leaf Chain Selection	39
Leaf Chain.....	40
AL Series	40
BL Series	41
Motorcycle Chain.....	42
Nickel Plated Chain.....	44
Side Bow	46
Self Lubricating Chain.....	47
Stainless Steel Chain.....	48
Stainless Steel Double Pitch Chain ...	49
Straight Side Plate Chain	50
A&CA Chain	50
Handling, Installation & Operation....	51
Inspection & Maintenance	53
Lubrication	54

KCM (Japan) – Kaga Industries Co. Ltd

Founded in 1956 KCM is an exclusive roller chain manufacturer certified by ISO 9001 (International Quality Management and Assurance Standard). This certification was attained on April 4, 1995 through examination by SGS Yarsley ICS.

KCM Strives to maintain its world recognized quality products, which meet the expectations of our satisfied customers.

Using state of the art manufacturing and quality assurance technology, KCM is exclusively dedicated to the production of the Finest Quality Roller Chains and Conveyor Chains available.

This Dedication to Quality helps to insure the Reliability of The Products which KCM's Customers Produce.

NB. Most chain sizes listed in this section are stocked items although some are not. Please confirm availability with your Finer Representatives.

Roller Chains: indispensable drive and transfer components in modern industries, to meet diversified needs of the times. Roller chains are composed of five component parts as shown below.



CHAIN PARTS

OUTER LINKS



Riveted



Double cotter
(KCM 80 ~ KCM 160)



Long solid cotter
(KCM 200 ~ KCM 240)

CONNECTING LINKS



Open type clip



Closed type clip



Cotter type

OFFSET LINKS



One pitch offset link



Two pitch offset link

CHAIN



Riveted chain



Cottered chain

General Roller Chain Selection Method

For roller chain transmission, it is important to select appropriate roller chain and sprockets.

1 Compensated chain drive power

2 Power to be transmitted

Determine the compensated chain drive power by multiplying the power to be transmitted by service factor shown in Table 2 according to the driven machine and prime mover. If the desired power transmission power cannot be achieved with single strand chain, select multiple strand chain. In this case, it is required to make compensation with multiple strand factor listed in Table 1 as follows.

○ Single strand chain:
Compensated chain drive power
= Power to be transmitted × Service factor

○ Multiple strand chain:
Compensated chain drive power
= Power to be transmitted × Service factor
multiple strand factor

3 Speeds of drive and driven shafts:

Determine appropriate roller chain and number of teeth of smaller sprocket from Table 3 "Quick selection chart" according to the speed (rpm) of higher-speed shaft (drive shaft in case of deceleration and driven shaft in acceleration) and compensated chain drive power. In this case, it is recommended to select a chain with pitches as small as possible for smooth, quiet operation.

4 Shaft diameter and boss diameter:

After determining the number of teeth of smaller sprocket, refer to Sprocket dimensions tables on pages 77 to 86 to find boss diameter and maximum bore diameter. If the bore diameter is less than the actual shaft diameter, reselect the increased number of teeth of smaller sprocket so that the bore diameter matches the actual shaft diameter.

5 Speed ratio of both shafts

Determine the number of teeth of larger sprocket by multiplying the number of teeth of smaller sprocket by the speed ratio of smaller sprocket to larger sprocket. Here, note that the number of teeth of smaller sprocket must be 17 or more, and that of larger sprocket must be 114 or less.

When uniform load is transferred at low speed, it is possible to select a sprocket whose number of teeth is down to 13.

In roller chain drive, the speed ratio of smaller sprocket to larger sprocket is normally 7 : 1 or less. If larger speed ratio is required, select two or more stages for speed change.

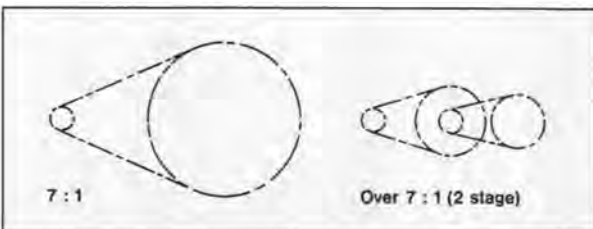

6 Shaft-to-shaft distance

It is ideal that shaft-to-shaft distance is 30 to 50 times chain pitch employed, although both shaft are positioned close to each other just before engagement of both sprockets. If subjected to pulsating load, shaft-to-shaft distance must be 20 or less times chain pitch employed.

Low Speed Roller Chain Selection Method

When the chain speed is 50 m/min or less, follow the "Low Speed Roller Chain Selection Method", rather than "General Roller Chain Selection Method", described above, for economical operation.

This low speed roller chain selection method is suitable for smooth power transmission with less frequent starts and stops. Working conditions such as operating environment, arrangement and lubrication are similar to those of general roller chain selection method.

1 Chain Speed

$$V = \frac{P \cdot N \cdot n}{1000}$$

V: Chain speed, m/min

P: Chain pitch, mm

N: No. of teeth of smaller sprocket

n: No. of speed of smaller sprocket. rpm

2 Load acting on roller chain

$$F = \frac{6120 \cdot kW}{V}$$

F: Max. load acting on roller chain, kgf

kW: Transmission Power, kW

3 Max. acting load and max. allowable load

$$\text{Max. load acting on chain, kgf} \times \text{Service factor Table 2} \times \text{Speed factor Table 4} \leq \text{Ma. allowable load of roller chain, kg}$$

Table 4 Speed Factors

Chain speed	Speed factor
15 m/min or less	1.0
15~30m/min	1.2
30~50m/min	1.4

If the foregoing equation is not satisfied, change the size of roller chain and the number of teeth of sprocket, and try to recheck if the equation is satisfied or not.

4 For low-speed application subjected to frequent starts and stops or braking and shocks, contact us.

Required Roller Chain Length

The required roller chain length (number of pitches) can be determined by the following equation, using center-to-center distance between shafts and number of teeth of sprocket.

$$L_p = \frac{N_1 + N_2}{2} + 2C_p + \frac{|(N_2 - N_1) / 2\pi|^2}{C_p}$$

L_p : Overall roller chain length (no. of pitches)

N_1 : Number of teeth of smaller sprocket

N_2 : Number of teeth of larger sprocket

C_p : Center-to-center distance between shafts (no. of pitches)

$\{(N_2 - N_1) / 2\pi\}^2$ can be found from the table below.

$N_2 - N_1$	$\{(N_2 - N_1) / 2\pi\}^2$	$N_2 - N_1$	$\{(N_2 - N_1) / 2\pi\}^2$	$N_2 - N_1$	$\{(N_2 - N_1) / 2\pi\}^2$
1	0.03	35	31.06	69	120.72
2	0.10	36	32.86	70	124.24
3	0.23	37	34.71	71	127.82
4	0.41	38	36.61	72	131.45
5	0.63	39	38.57	73	135.12
6	0.91	40	40.57	74	138.85
7	1.24	41	42.62	75	142.63
8	1.62	42	44.73	76	146.46
9	2.05	43	46.88	77	150.34
10	2.54	44	49.09	78	154.27
11	3.07	45	51.35	79	158.25
12	3.65	46	53.65	80	162.28
13	4.29	47	56.01	81	166.36
14	4.97	48	58.42	82	170.49
15	5.71	49	60.88	83	174.68
16	6.49	50	63.39	84	178.91
17	7.33	51	65.95	85	183.20
18	8.22	52	68.56	86	187.53
19	9.15	53	71.22	87	191.92
20	10.14	54	73.94	88	196.36
21	11.18	55	76.70	89	200.84
22	12.27	56	79.52	90	205.38
23	13.41	57	82.38	91	209.97
24	14.61	58	85.30	92	214.61
25	15.85	59	88.26	93	219.30
26	17.14	60	91.28	94	224.05
27	18.48	61	94.35	95	228.84
28	19.88	62	97.47	96	233.68
29	21.32	63	100.64	97	238.57
30	22.82	64	103.86	98	243.52
31	24.37	65	107.13	99	248.51
32	25.96	66	110.45	100	253.56
33	27.61	67	113.82		
34	29.31	68	117.25		

NOTE
 L_p (number of pitches), determined by the equation above, is not integer, almost having fraction part. Therefore, it is necessary to round up the function part to obtain integer. If the round-up integer is odd number, use an offset link, but even number is preferable.

Center-to-center Distance between Drive and Driven Shafts

The required roller chain length (number of pitches) determined at left is just approximation; which does not coincide with arbitrary center-to-center distance of drive and driven shafts. Therefore, it is required to obtain accurate center-to-center distance of drive and driven shafts. Therefore, it is required to obtain accurate center-to-center distance of drive and driven shafts by making calculation based on the required roller chain length equation.

$$C_p = \frac{1}{4} \left\{ L_p - \frac{N_1 + N_2}{2} + \sqrt{\left(L_p - \frac{N_1 + N_2}{2} \right)^2 - \frac{2}{\pi^2} (N_2 - N_1)^2} \right\}$$

C_p : Center-to-center distance between both drive and driven shafts (pitches)

L_p : Overall chain length (pitches)

N_1 : No. of teeth of smaller sprocket

N_2 : No. of teeth of larger sprocket

$\frac{2}{\pi^2} (N_2 - N_1)^2$ can be found from the table below.

$N_2 - N_1$	$\frac{2}{\pi^2} (N_2 - N_1)^2$	$N_2 - N_1$	$\frac{2}{\pi^2} (N_2 - N_1)^2$	$N_2 - N_1$	$\frac{2}{\pi^2} (N_2 - N_1)^2$
1	0.20	35	248.49	69	9965.76
2	0.81	36	262.89	70	9993.95
3	1.83	37	277.70	71	1022.56
4	3.25	38	292.91	72	1051.56
5	5.07	39	308.53	73	1080.98
6	7.30	40	324.56	74	1110.80
7	9.94	41	340.99	75	1141.19
8	12.98	42	357.82	76	1171.65
9	16.43	43	375.07	77	1202.69
10	20.28	44	392.71	78	1234.13
11	24.54	45	410.77	79	1265.97
12	29.21	46	429.23	80	1298.23
13	34.28	47	448.09	81	1330.88
14	39.76	48	467.36	82	1363.95
15	45.64	49	487.04	83	1397.42
16	51.93	50	507.12	84	1431.29
17	58.62	51	527.61	85	1465.58
18	65.72	52	548.50	86	1500.26
19	73.23	53	569.80	87	1535.36
20	81.14	54	591.50	88	1570.85
21	89.46	55	613.61	89	1606.76
22	98.18	56	636.13	90	1643.07
23	107.31	57	659.05	91	1679.78
24	116.84	58	682.38	92	1716.90
25	126.78	59	706.11	93	1754.43
26	137.13	60	730.25	94	1792.36
27	147.88	61	754.80	95	1830.70
28	159.03	62	779.75	96	1869.45
29	170.60	63	805.10	97	1908.60
30	182.56	64	830.86	98	1948.15
31	194.94	65	857.03	99	1988.11
32	207.92	66	883.61	100	2028.48
33	220.90	67	910.58		
34	234.49	68	937.97		

Use in Severe Working Conditions

1. Application at High Temperature

If the chain is heated, its strength and wear resistance are decreased.

Table 5 Atmospheric temperature and strength

Atmospheric temp (°C)	Strength
Up to -30	Allowable tensile force* × 0.25
-30 to -20	// × 0.30
-10 to 150	// × 1
150 to 200	// × 0.75
200 to 250	// × 0.5

2. Described in catalog

For use in alkalic or acidic environment, it is required to use the chain made of material having high corrosion resistance, for instance, stainless steel. Note that corrosion resistance of stainless steel may be decreased significantly according to kinds of liquid and gas, and operating temperatures.

Installation

(A) Arrangement of Shafts

Horizontal arrangement;

Even if both shafts are arranged horizontally, pay due attention to rotational direction of the shafts. In cases of Fig. (2) and (3), there is a fear that the chain is disengaged from the sprocket when the chain is elongated. Particularly, in the case of Fig. (3), there is a fear that the upper and lower chain parts make contact: use an idler at midspan between shafts as shown.

Vertical arrangement:

The chain, if elongated, will be deflected as illustrated in Fig. (5). Particularly, if a smaller sprocket is located at the bottom side, there is a concern that the chain can disengage from the sprocket. To avoid disengagement, it is required the line linking centers of both shafts is at 60° or less to horizontal line, as illustrated in Fig. (4). If this arrangement is not allowed due to limitation of mechanism or space, it is recommended to arrange a larger sprocket at the lower side, and an idler inside or outside the chain as illustrated in Fig. (6).

(B) Sag

Sag of the chain is approximately 4% of shaft-to-shaft distance, and approximately 2% of that in the following cases*

- 1) Vertical arrangement or similar arrangement.
- 2) Shaft-to-shaft distance is 1 m or longer.
- 3) Frequent starts and stops under heavy load.
- 4) Reversing operation

(C) Varying loads

It is required to place a tensioner on the tensed side or slackened side of the chain to give pre-tension. This eliminates vibration in operation and reduces noise.

Horizontal arrangement:

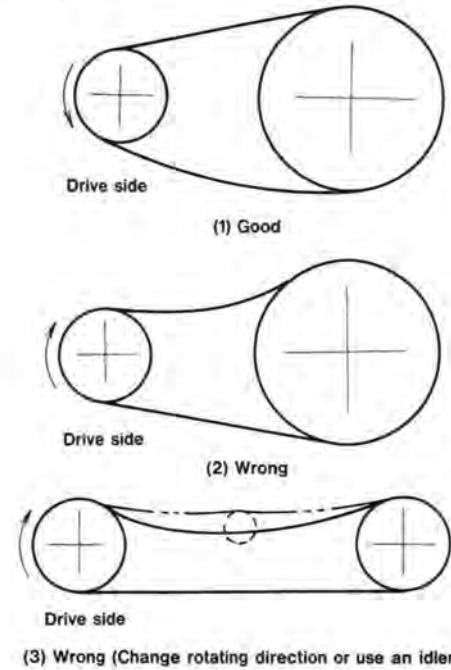

Vertical arrangement:

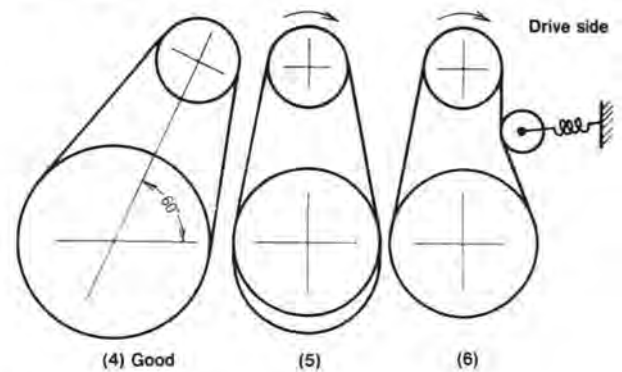

Examples of Tensioners

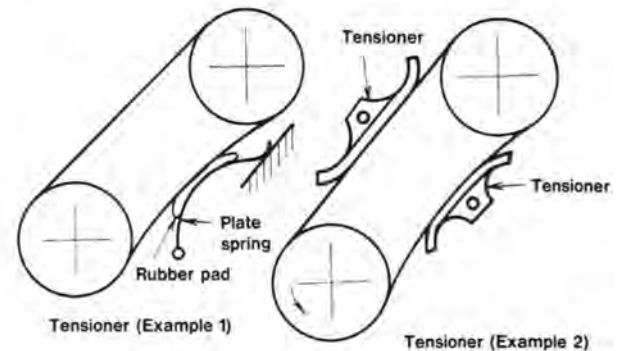

Power Transmission Capacity Tables

Power Transmission capacities of the KCM products shown in this catalog are determined under the following conditions:

- 1) Operation at -10°C to +60°C in the atmosphere free from abrasive dirt.
- 2) No corrosive gas and high humidity.
- 3) Two sprockets on which roller chain is mounted are properly aligned on parallel, level shafts.
- 4) Use of lubricant and lubrication method.
- 5) Less loading variations.

Multiple strand factor (Table 1)

Power transmission capacity of multiple strand roller chain is not equal to the number of strands times that of single strand roller chain, because the load is not evenly distributed to respective strands of roller chains. Therefore, power transmission capacity of multiple strand roller chain is determined by multiplying that of single strand roller chain by multiple strand factor.

Service factor (Table 2)

Actual power transmission capacity is adjusted according to the degree of loading variations, because the power transmission capacity tables are prepared on condition that loading variations are small.

Quick Selection Chart (Table 3)

How to Use:

EXAMPLE: Single strand roller chain with 5kW compensated chain drive power.

1. When smaller sprocket speed is 100 rpm:

Find the intersection of 5kW horizontal line of the compensated chain drive power and 100 rpm vertical line of the smaller sprocket speed in the quick selection chart. You'll find that the chain is KCM 80, and number of sprocket teeth is between 16T and 20T, judging as 17T from the exact location of the intersection.

2. When smaller sprocket speed is 300 rpm:

1) Find the intersection in the same way as 1, you'll find that the chain is KCM 60, and number of sprocket teeth is 13T to 18T, judging as 15T from the exact location of the intersection. Also, you'll find that there is KCM 50/24T line (dotted) near this intersection. This means you can use either KCM 60/15T and KCM 50/24T. After making quick selection with this chart confirm the selected sprocket is appropriate with reference to the power transmission capacity tables.

2) For power transmission capacity lines of 20T, 24T and 30T, only its high speed portions are shown to simplify the quick selection chart. For lower speed portions, extend a line in parallel to the lines, just like a dotted line of KCM50/24T.

3) For chain speeds of 50 m/min or lower, it is economical to make selection by "Low speed selection method" described later.

Table 1 Multiple strand factor

NO. of Chain Strands	Multiple Strand factor
2 strands	1.7
3 strands	2.5
4 strands	3.3
5 strands	3.9
6 strands	4.6

Table 2 Service factor

Load	Prime mover Priven machine	Motor turbine	Combustion engine	
			W/hyd. equipment	W/o hyd. equipment
Smooth loading	Belt conveyor subjected to small loading variations, chain conveyor, centrifugal pump, centrifugal blower, textile machine, and other machinery subjected to small loading variations.	1.0	1.0	1.2
With some shocks	Centrifugal compressor, marine propulsion system, conveyor subjected to some loading variations, automatic furnace, drier, crusher, machine tool, compressor.	1.3	1.2	1.4
With heavy shocks	construction machinery, and paper mill, press, crusher, mining machinery, vibrator, oil-well machinery, rubber mixer, roll, roll gang, and other machinery subjected to reversing loads or heavy shocks	1.5	1.4	1.7

Table 3 Quick Selection Chart

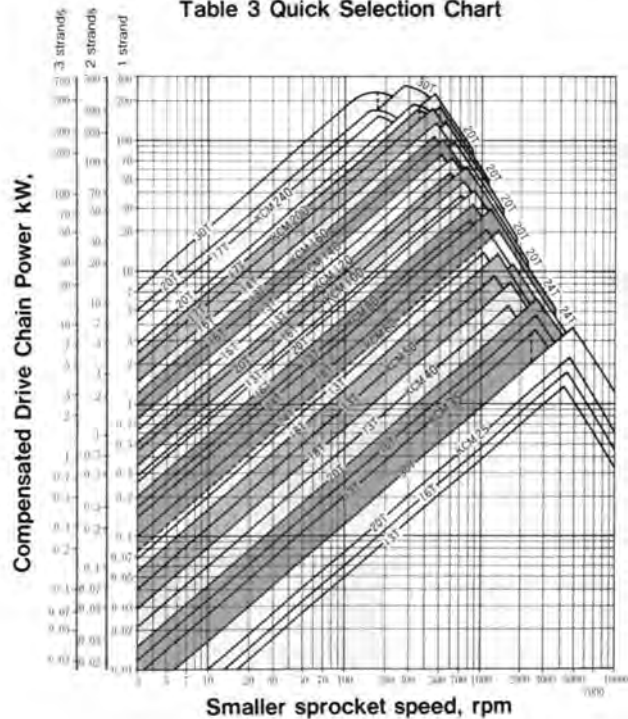

ANSI Standard Roller Chain



13 types of KCM standard rollers, conforming to JIS and ANSI, chains are available.

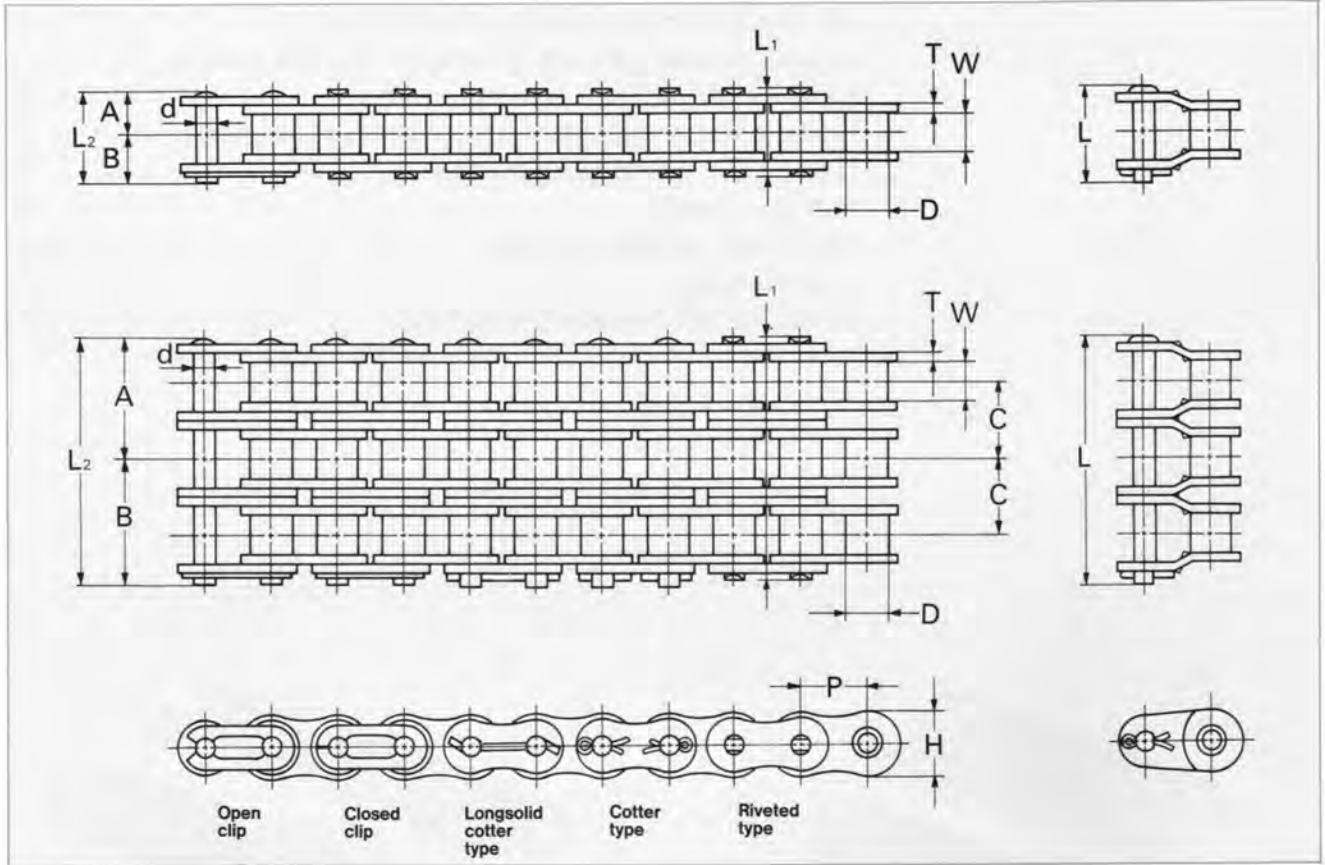

Dimensions (millimeters)

Chain No.	Pitch	Width between inner plates	Roller diameter	Pin					Link plate		JIS&ANSI Tensile strength	Average Tensile strength	Maximum Allowable Load	Approx weight	Links of 1 unit		
				Diameter	A	B	(A + A)	(A + B)	Offset	Thickness						Height	
KCM	JIS&ANSI	P	W	D	d	A	B	L ₁	L ₂	L	T	H	kgf (kN)	kgf (kN)	kgf (kN)	(kg/m)	
25	25	6.35	3.18	* 3.30	2.31	3.80	4.80	7.60	8.60		0.75	5.8	357 (3.5)	450 (4.4)	65 (0.64)	0.13	480
35	35	9.525	4.78	* 5.08	3.59	5.70	7.10	11.40	12.80	13.65	1.25	8.8	806 (7.9)	1,100 (10.8)	220 (2.16)	0.33	320
41	41	12.70	6.38	7.77	3.59	6.52	7.93	13.05	14.45	14.95	1.25	9.5	683 (6.7)	1,200 (11.8)	230 (2.26)	0.40	240
40	40	12.70	7.95	7.95	3.97	8.02	9.53	16.05	17.55	18.95	1.5	11.7	1,407 (13.8)	1,850 (18.1)	370 (3.63)	0.61	240
50	50	15.875	9.53	10.16	5.09	10.15	11.60	20.30	21.75	23.00	2.0	14.6	2,223 (21.8)	3,050 (29.9)	650 (6.37)	1.01	192
60	60	19.05	12.70	11.91	5.96	12.65	14.15	25.30	26.80	29.45	2.4	17.5	3,172 (31.1)	4,200 (41.2)	900 (8.83)	1.49	160
80	80	25.40	15.88	15.88	7.94	16.07	19.18	32.15	35.25	36.90	3.2	23.0	5,670 (55.6)	7,400 (72.6)	1,500 (14.71)	2.50	120
100	100	31.75	19.05	19.05	9.54	20.10	23.05	40.20	43.15	45.05	4.0	28.9	8,841 (86.7)	11,500 (112.8)	2,300 (22.56)	3.85	96
120	120	38.10	25.40	22.23	11.11	25.20	28.60	50.40	53.80	55.90	4.8	35.0	12,706 (124.6)	16,000 (156.9)	3,100 (30.40)	5.66	80
140	140	44.45	25.40	25.40	12.71	27.30	31.30	54.60	58.60	60.50	5.6	40.7	17,233 (169.0)	21,500 (210.8)	4,100 (40.21)	7.19	68
160	160	50.80	31.75	28.58	14.29	32.45	37.15	64.90	69.60	71.85	6.4	46.7	22,678 (222.4)	27,500 (269.7)	5,400 (52.96)	9.63	60
200	200	63.50	38.10	39.68	19.86	39.65	46.65	79.30	86.30	89.20	8.0	58.4	35,384 (347.0)	48,000 (470.7)	7,300 (71.59)	15.97	48
240	240	76.20	47.63	47.63	23.81	48.20	55.60	96.40	103.80	107.00	9.5	72.4	51,027 (500.4)	70,000 (686.5)	10,100 (99.05)	24.50	40

NOTES: - KCM 25 offset link is 2-pitch type.
 - Asterisk (*) implies bush diameter.
 - Connecting links of KCM 25 to KCM 60 are clip type. (Both open and closed clips are available.)
 - Connecting links of KCM 80 or larger models are split pin type.



ANSI Standard Roller Chain (Multiple Strand Type)

12 types of multiple roller chains, conforming to JIS and ANSI, are available.

Dimensions (millimeters)

Chain No.	Pitch P	Width between inner plates W	Roller diameter D	Pin					Link plate		Transverse pitch C	JIS&ANSI Tensile strength kgf (kN)	Average Tensile strength kgf (kN)	Maximum Allowable Load kgf (kN)	Approx weight (kg/m)	Links of 1 unit			
				Diameter d	A	B	(A+A) L ₁	(A+B) L ₂	Offset L	Thick- ness T							Height H		
25-2	25-2	6.35	3.18	*3.30	2.31	7.00	8.00	14.00	15.00		0.75	5.8	6.4	714(7.0)	900(8.8)	110(1.08)	0.26	480	
25-3	25-3					10.20	11.20	20.40	21.40						1,071(10.5)	1,350(13.2)	160(1.57)		0.39
35-2	35-2	9.525	4.78	*5.08	3.59	10.75	12.15	21.50	22.90	23.75	1.25	8.8	10.1	1,612(15.8)	2,200(21.6)	370(3.63)	0.64	320	
35-3	35-3					15.80	17.20	31.60	33.00	33.85					2,418(23.7)	3,300(32.4)	550(5.39)		0.95
40-2	40-2	12.70	7.95	7.95	3.97	15.22	16.73	30.45	31.95	33.35	1.5	11.7	14.4	2,814(27.6)	3,700(36.3)	630(6.17)	1.19	240	
40-3	40-3					22.42	23.93	44.85	46.35	47.75					4,221(41.4)	5,550(54.4)	930(9.11)		1.79
40-4	40-4					29.62	31.13	59.25	60.75	62.15					5,628(55.2)	7,400(72.6)	1,220(11.96)		2.38
40-5	40-5					36.82	38.33	73.65	75.15	76.55					7,035(69.0)	9,250(90.7)	1,440(14.12)		2.96
50-2	50-2	15.875	9.53	10.16	5.09	19.20	20.65	38.40	39.85	41.10	2.0	14.6	18.1	4,446(43.6)	6,100(59.8)	1,100(10.79)	2.01	192	
50-3	50-3					28.25	29.70	56.50	57.95	59.20					6,669(65.4)	9,150(89.7)	1,620(15.89)		2.99
50-4	50-4					37.30	38.75	74.60	76.05	77.30					8,892(87.2)	12,200(119.6)	2,150(21.08)		3.99
50-5	50-5					46.35	47.80	92.70	94.15	95.40					11,115(109.0)	15,250(149.6)	2,530(24.81)		4.99
60-2	60-2					19.05	12.70	11.91	5.96	24.05				25.55	48.10	49.60	52.25		2.4
60-3	60-3	35.45	36.95	70.90	72.40					75.05		9,518(93.3)	12,600(123.5)	2,250(22.06)	4.41				
60-4	60-4	46.85	48.35	93.70	95.20					97.05		12,688(124.4)	16,800(164.6)	2,950(28.93)	5.83				
60-5	60-5	58.25	59.75	116.50	118.00					119.85		15,860(155.5)	21,000(205.8)	3,500(34.32)	7.32				
60-6	60-6	69.65	71.15	139.30	140.80					142.65		19,032(186.6)	25,200(247.0)	4,150(40.70)	8.78				
80-2	80-2	25.40	15.88	15.88	7.94					30.72	33.83	61.45	64.55	66.20	3.2	23.0	29.3	11,340(111.2)	
80-3	80-3					45.37	48.48	90.75	93.85	95.50		17,010(166.8)	22,200(217.7)	3,750(36.77)				7.40	
80-4	80-4					60.02	63.13	120.05	123.15	124.00		22,680(222.4)	29,600(290.3)	4,950(48.54)				9.84	
80-5	80-5					74.67	77.78	149.35	152.45	153.30		28,350(278.0)	37,000(362.8)	5,850(57.37)				12.29	
80-6	80-6					89.32	92.43	178.65	181.75	182.60		34,020(333.6)	44,400(435.4)	7,350(72.08)				14.73	
100-2	100-2					31.75	19.05	19.05	9.54	38.00	40.95	76.00	78.95	80.85				4.0	28.9
100-3	100-3	55.90	58.85	111.80	114.75					116.50		26,523(260.1)	34,500(338.3)	5,750(56.39)	11.38				
100-4	100-4	73.80	76.75	147.60	150.55					151.75		35,364(346.8)	46,000(451.1)	7,550(74.04)	15.15				
100-5	100-5	91.70	94.65	183.40	186.35					187.55		44,205(433.5)	57,500(563.9)	8,950(87.77)	18.91				
100-6	100-6	119.60	122.55	239.20	242.15					223.35		53,046(520.2)	69,000(676.7)	11,200(109.83)	22.68				
120-2	120-2	38.10	25.40	22.23	11.11					47.90	51.30	95.80	99.20	100.70	4.8	35.0	45.4		
120-3	120-3					70.60	74.00	141.20	144.60	146.10		38,118(373.8)	48,000(470.7)	7,750(76.00)				16.74	
120-4	120-4					93.30	96.70	186.60	190.00	191.50		50,824(498.4)	64,000(627.6)	10,200(100.03)				22.28	
120-5	120-5					116.00	119.40	232.00	235.40	236.90		63,530(623.0)	80,000(784.5)	12,050(118.17)				27.83	
120-6	120-6					138.70	142.10	277.40	280.80	282.30		76,236(747.6)	96,000(941.4)	15,150(148.57)				33.36	
140-2	140-2					44.45	25.40	25.40	12.71	51.75	55.75	103.50	107.50	108.95				5.6	40.7
140-3	140-3	76.20	80.20	152.40	156.40					157.85		51,699(507.0)	64,500(632.5)	10,250(100.52)	21.30				
140-4	140-4	100.65	104.65	201.30	205.30					206.75		68,932(676.0)	86,000(843.4)	13,500(132.39)	28.33				
160-2	160-2	50.80	31.75	28.58	14.29	61.70	66.40	123.40	128.10	130.35	6.4	46.7	58.5	45,356(444.8)	55,000(539.4)	9,150(89.73)	19.06	30	
160-3	160-3					90.95	95.65	181.90	186.60	188.85					68,034(667.2)	82,500(809.0)	13,500(132.39)		28.50
160-4	160-4					120.20	124.90	240.40	245.10	247.35					90,712(889.6)	110,000(1078.7)	17,800(174.56)		37.93
200-2	200-2	63.50	38.10	39.68	19.85	75.45	82.45	150.90	157.90	160.80	8.0	58.4	71.6	70,768(694.0)	96,000(941.4)	12,400(121.60)	31.59	24	
200-3	200-3					111.25	118.25	222.50	229.50	232.40					106,152(1041.0)	144,000(1412.2)	18,250(178.97)		47.29
200-4	200-4					147.05	154.05	294.10	301.10	304.00					141,536(1388.0)	192,000(1882.9)	24,050(235.85)		62.95
240-2	240-2	76.20	47.63	47.63	23.81	92.10	99.50	184.10	191.60	194.80	9.5	72.4	87.8	102,054(1000.8)	140,000(1372.9)	17,150(168.18)	48.10	40	
240-3	240-3					136.00	143.40	272.00	279.40	282.60					153,081(1501.2)	210,000(2059.4)	25,250(247.62)		71.61
240-4	240-4					179.90	187.30	358.80	367.20	370.40					204,108(2001.6)	280,000(2745.9)	33,300(326.56)		95.11

NOTES: - KCM25 offset link is 2-pitch type.
 - Asterisk (*) implies bush diameter.
 - Connecting links of KCM 25 to KCM 60 are clip type. (Both open and closed clips are available.)
 - Connecting links of KCM 80 or larger models are split pin type.

BS Roller Chain



ISO-B Series roller chains, conforming to ISO 606-B, are available to Europe-built equipment.

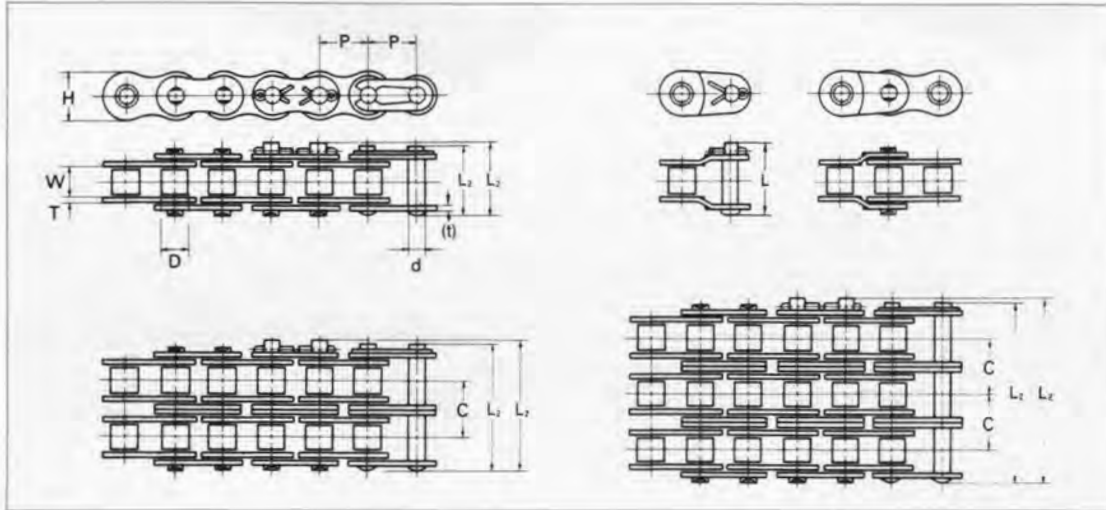

Dimensions (millimeters)

KCM Chain Number	Pitch P	Width between inner plates W	Roller diameter D	Pin			Link plate		Transverse pitch C	ISO 606 Minimum Tensile strength kgf (kN)	KCM Minimum Tensile strength kgf (kN)	Approx weight (kg/m)	Links of 1 unit			
				Diameter d	L ₂	Offset L	Thickness T	Height H								
KCM 03	5.00	2.50	3.20	1.49	7.65		0.75	4.0		270 (2.6)	0.09	1000				
KCM 04	6.00	2.80	4.00	1.85	7.35		0.6	4.9		330 (3.2)	0.11	834				
KCM 05B	8.00	3.00	5.00	2.31	8.60		0.75	7.1	5.64	460 (4.5)	500 (4.9)	0.18	626			
KCM 05B-2					14.25									800 (7.8)	870 (8.5)	
KCM 05B-3					19.90											1,140 (11.2)
KCM 06B	9.525	5.72	6.35	3.28	13.60	15.15	1.3 (1.0)	8.1	10.24	910 (8.9)	1,000 (9.8)	0.39	320			
KCM 06B-2					23.85	25.40								1,730 (17.0)	1,900 (18.6)	0.74
KCM 06B-3					34.09	35.65								2,540 (24.9)	2,790 (27.4)	1.10
KCM 08B	12.70	7.75	8.51	4.45	17.75	19.20	1.5	11.7	13.92	1,820 (17.8)	1,850 (18.1)	0.65	240			
KCM 08B-2					31.65	33.10								3,180 (31.2)	3,250 (31.9)	1.25
KCM 08B-3					45.55	47.00								4,540 (44.5)	4,600 (45.1)	1.85
KCM 10B	15.875	9.65	10.16	5.08	20.60	21.95	1.65	14.6	16.59	2,270 (22.3)	2,500 (24.5)	0.92	192			
KCM 10B-2					37.20	38.55								4,540 (44.5)	5,000 (49.0)	1.82
KCM 10B-3					53.80	55.15								6,810 (66.8)	7,500 (73.5)	2.71
KCM 12B	19.05	11.68	12.07	5.72	23.60	26.30	1.8	16.0	19.46	2,950 (28.9)	3,250 (31.9)	1.24	160			
KCM 12B-2					43.05	45.75								5,900 (57.9)	6,500 (63.7)	2.44
KCM 12B-3					62.50	65.20								8,850 (86.8)	9,750 (95.6)	3.65
KCM 16B	25.40	17.02	15.88	8.28	38.10	41.45	4.0 (3.2)	19.7	31.88	4,310 (42.3)	6,500 (63.7)	2.62	120			
KCM 16B-2					70.00	73.35								8,620 (84.5)	12,350 (121.1)	5.18
KCM 16B-3					101.90	105.25								12,930 (126.8)	18,200 (178.5)	7.74
KCM 20B	31.75	19.05	19.05	10.19	43.95	47.25	4.5 (3.5)	26.0	36.45	6,580 (64.5)	10,500 (103.0)	3.81	96			
KCM 20B-2					80.40	83.70								13,160 (129.1)	19,900 (195.1)	7.52
KCM 20B-3					116.85	120.15								19,740 (193.6)	29,300 (278.3)	11.24
KCM 24B	38.10	25.40	25.40	14.63	58.70	64.20	6.0 (5.0)	33.0	48.36	9,980 (97.9)	18,700 (183.4)	6.65	80			
KCM 24B-2					107.05	112.55								19,960 (195.7)	35,650 (349.6)	13.11
KCM 24B-3					155.40	160.90								29,940 (293.6)	52,600 (515.8)	19.57

NOTE: Spring clip type connecting links are used to chains No. 03 to 12B; low pitch offset links only are to be used for 03 to 05B

Double-pitch roller chain, whose pitch is doubled compared to standard roller chain, employs parts of standard roller chain except for link plate. Therefore, the length and strength are the same, but the number of parts is reduced to a half, reducing weight and improving economy. This roller chain is suited for relatively long power transmission at low speed.

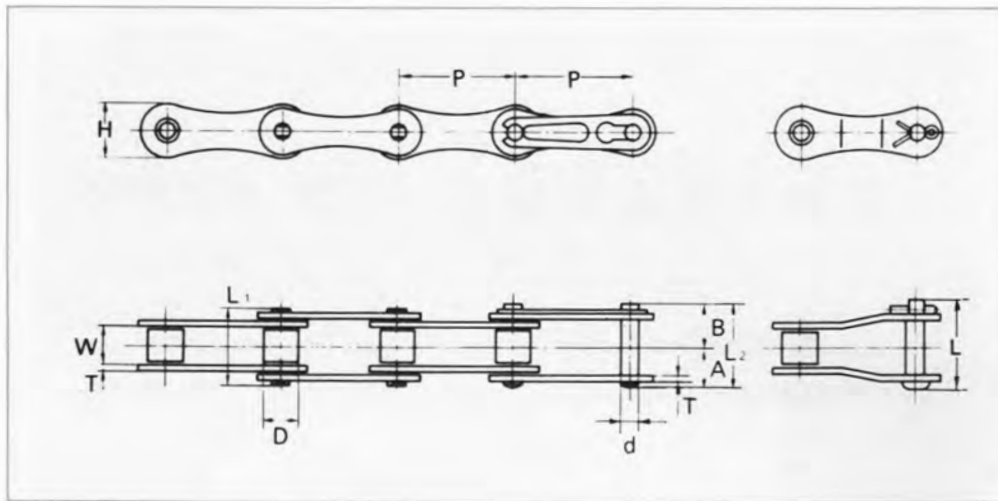

Dimensions (millimeters)

KCM Chain Number	Pitch P	Width between inner plates W	Roller diameter D	Pin						Link plate		Average Tensile strength kgf (kN)	Maximum Allowable Load kgf (kN)	Approx weight (kg/m)	Links of 1 unit
				Diameter d	A	B	(A+A) L ₁	(A+B) L ₂	Offset L	Thickness T	Height H				
KCM A2040	25.40	7.95	7.95	3.97	8.02	9.53	16.05	17.55	18.95	1.5	11.7	1,750 (17.2)	280 (2.75)	0.40	120
KCM A2050	31.75	9.35	10.16	5.09	10.15	11.60	20.30	21.75	23.00	2.0	14.6	2,850 (27.9)	450 (4.41)	0.65	96
KCM A2060	38.10	12.70	11.91	5.96	12.65	14.15	25.30	26.80	29.45	2.4	17.5	4,000 (39.5)	640 (6.28)	0.95	80
KCM A2080	50.80	15.88	15.88	7.94	16.07	19.18	32.15	35.25	36.90	3.2	23.0	7,000 (68.6)	1,090 (10.69)	1.74	60

NOTE: Connecting link for the A2080 or larger models use split pins.

Double Pitch Chain



The double pitch roller chains for conveyor fall into two roller types: S types (KCM chain No. is suffixed with "0") and R types (KCM chain No. suffixed with "2") Using a variety of standard attachments, the double pitch roller chain can be used as a compact, high-precision conveyor. Nickel plated models as well as stainless steel models are also available.

S Roller Type



R Roller Type

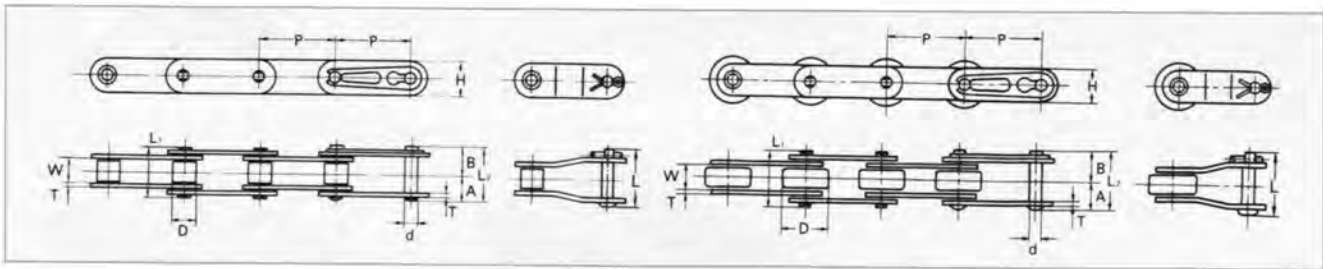

Dimensions (millimeters)

KCM Chain Number	Pitch P	Width between inner plates W	Roller diameter D	Pin						Link plate		Average Tensile strength kgf (kN)	Maximum Allowable Load kgf (kN)	Approx weight (kg/m)	Links of 1 unit
				Diameter d	A	B	(A+A) L ₁	(A+B) L ₂	Offset L	Thickness T	Height H				
KCM C2040 KCM C2042	25.40	7.95	7.95 15.88	3.97	8.02	9.53	16.05	17.55	18.95	1.5	11.7	1,750(17.2)	280(2.75)	0.48 0.82	120
KCM C2050 KCM C2052	31.75	9.53	10.16 19.05	5.09	10.15	11.60	20.30	21.75	23.00	2.0	14.6	2,850(27.9)	450(4.41)	0.79 1.25	96
KCM C2060 KCM C2062	38.10	12.70	11.91 22.23	5.96	12.65	14.15	25.30	26.80	29.45	2.4	17.5	4,000(39.5)	640(6.28)	1.12 1.79	80
KCM C2060H KCM C2062H	38.10	12.70	11.91 22.23	5.96	14.25	15.75	28.50	30.00	32.65	3.2	17.5	4,000(39.5)	640(6.28)	1.43 2.11	80
KCM C2080 KCM C2082	50.80	15.88	15.88 28.58	7.94	16.07	19.18	32.15	35.25	36.90	3.2	23.0	7,000(68.6)	1,090(10.69)	1.88 2.92	60
KCM C2080H KCM C2082H	50.80	15.88	15.88 28.58	7.94	17.70	20.80	35.40	38.50	40.15	4.0	23.0	7,000(68.6)	1,090(10.69)	2.37 3.41	60
KCM C2100H KCM C2102H	63.50	19.05	19.05 39.68	9.54	21.72	24.68	43.45	46.40	47.60	4.8	28.9	10,900(106.9)	1,740(17.06)	3.53 5.68	48
KCM C2120H KCM C2122H	76.20	25.40	22.23 44.45	11.11	26.85	30.25	53.70	57.10	59.30	5.6	35.0	15,200(149.1)	2,440(23.93)	4.75 7.40	40

NOTE: Connecting link for the KCM 80 or larger models use split pins.



H-Type Roller Chain

KCM H-type roller chains are designed for heavy-duty operation thickening the link plate of standard roller chains and using high-strength pins.

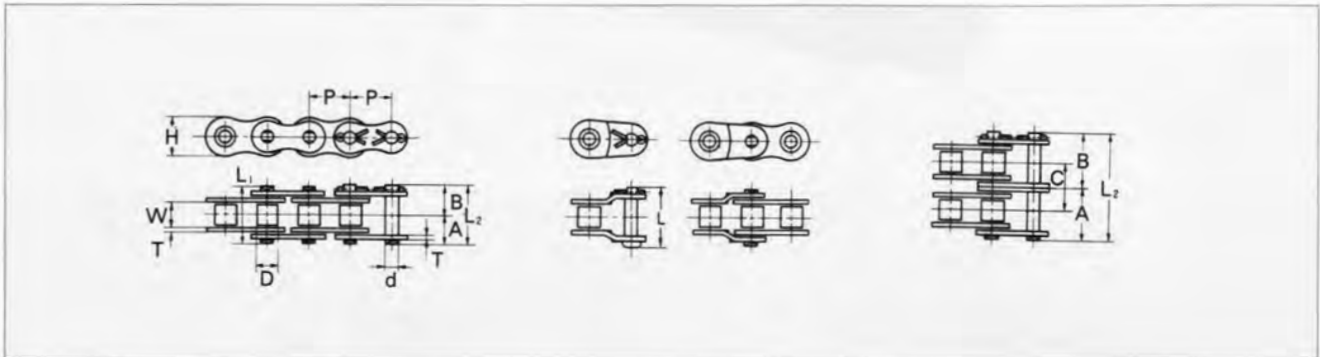

Dimensions (millimeters)

KCM Chain Number	Pitch P	Width between inner plates W	Roller diameter D	Pin						Link plate		Transverse pitch C	Average Tensile strength kgf (kN)	Maximum Allowable Load kgf (kN)	Approx weight (kg/m)	Links of 1 unit
				Diameter d	A	B	(A + A) L ₁	(A + B) L ₂	Offset L	Thickness T	Height H					
KCM 40H	12.70	7.95	7.95	3.97	9.05	10.55	18.10	19.60	21.00	2.0	11.7	16.4	2,400 (23.5)	400 (3.92)	0.73	240
KCM 40H-2					17.25	18.75	34.50	36.00	37.40				4,800 (47.0)	680 (6.67)		
KCM 50H	15.875	9.53	10.16	5.09	10.98	12.42	21.95	23.40	24.65	2.4	14.6	19.6	3,700 (36.2)	670 (6.57)	1.43	192
KCM 50H-2					20.78	22.22	41.55	43.00	44.25				7,400 (72.5)	1,140 (11.18)		
KCM 60H	19.05	12.70	11.91	5.96	14.25	15.75	28.50	30.00	32.65	3.2	17.5	26.1	5,100 (50.0)	980 (9.60)	1.77	160
KCM 60H-2					27.30	28.80	54.60	56.10	58.80				10,200 (100.0)	1,660 (16.27)		
KCM 80H	25.40	15.88	15.88	7.94	17.70	20.80	35.40	38.50	40.15	4.0	23.0	32.6	9,100 (89.2)	1,650 (16.18)	2.96	120
KCM 80H-2					34.00	37.10	68.00	71.10	72.80				18,200 (178.5)	2,800 (27.45)		
KCM 100H	31.75	19.05	19.05	9.54	21.71	24.68	43.45	46.40	48.30	4.8	28.9	39.1	13,100 (128.5)	2,500 (24.50)	4.17	96
KCM 100H-2					41.27	44.23	82.55	85.50	87.40				26,200 (256.9)	4,250 (41.67)		
KCM 120H	38.10	25.40	22.23	11.11	26.85	30.25	53.70	57.10	59.20	5.6	35.0	48.9	17,900 (175.5)	3,350 (31.84)	6.28	80
KCM 120H-2					51.30	54.70	102.60	106.00	108.10				35,800 (351.1)	5,690 (55.78)		
KCM 140H	44.45	25.40	25.40	12.71	28.95	32.95	57.90	61.90	63.80	6.4	40.7	52.2	23,400 (229.5)	4,400 (43.13)	7.83	68
KCM 140H-2					55.05	59.05	110.10	114.10	116.00				46,800 (459.0)	7,400 (72.55)		

NOTES: • Connecting links of KCM 40H to KCM 60H are clip type.
 • Single strand chain can be used with KCM standard sprockets.
 • Multiple strand chain is separately manufactured because center to center distance of rollers "C" is different from that of standard type.

HE-Type Roller Chain



HE-Series high-strength roller chains are designed for extra strength and resistance to fatigue higher than those of H-type. The HE-Series is best suited for heavy-duty power transmission with significant loading variations.

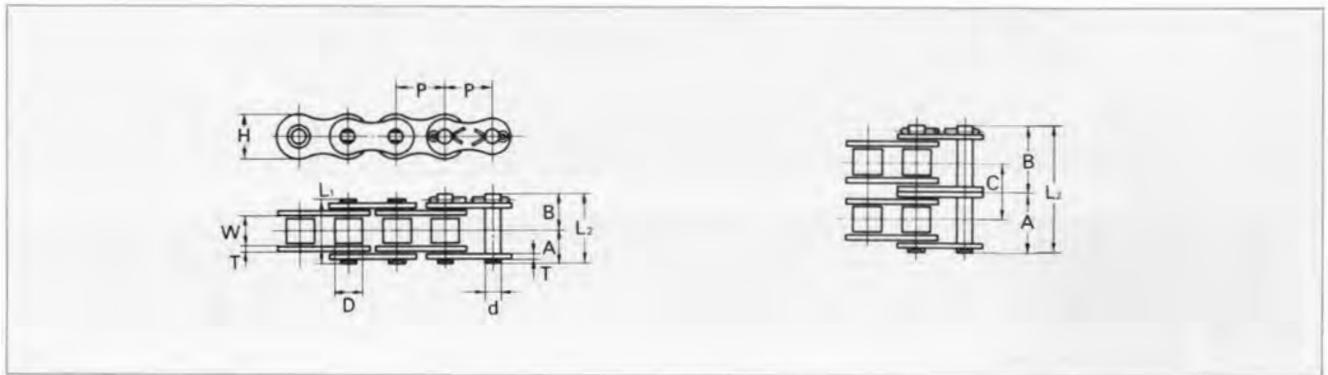

Dimensions (millimeters)

KCM Chain Number	Pitch P	Width between inner plates W	Roller diameter D	Pin					Link plate		Transverse pitch C	Average Tensile strength kgf (kN)	Maximum Allowable Load kgf (kN)	Approx weight (kg/m)	Links of 1 unit
				Diameter d	A	B	(A+A) L ₁	(A+B) L ₂	Thickness T	Height H					
KCM 40HE	12.70	7.95	7.95	3.97	9.05	10.55	18.10	19.60	2.0	11.7	16.4	2,400(23.5)	430(4.22)	0.73	240
KCM 40HE-2					17.25	18.75	34.50	36.00				4,800(47.1)	730(7.16)	1.45	
KCM 50HE	15.875	9.53	10.16	5.09	10.98	12.42	21.95	23.40	2.4	14.6	19.6	3,700(36.3)	680(6.67)	1.43	192
KCM 50HE-2					20.78	22.22	41.55	43.00				7,400(72.6)	1,150(11.28)	2.83	
KCM 60HE	19.05	12.70	11.91	5.96	14.25	15.75	28.50	30.00	3.2	17.5	26.1	5,700(55.9)	1,000(9.81)	1.77	160
KCM 60HE-2					27.30	28.80	54.60	56.10				11,400(111.8)	1,700(16.67)	3.56	
KCM 80HE	25.40	15.88	15.88	7.94	17.70	20.80	35.40	38.50	4.0	23.0	32.6	9,500(93.2)	1,700(16.67)	2.96	120
KCM 80HE-2					34.00	37.10	68.00	71.10				19,000(186.3)	2,890(28.34)	5.84	
KCM 100HE	31.75	19.05	19.05	9.54	21.71	24.68	43.45	46.40	4.8	28.9	39.1	14,600(143.2)	2,650(25.99)	4.17	96
KCM 100HE-2					41.27	44.23	82.55	85.50				29,200(286.4)	4,500(44.13)	8.23	
KCM 120HE	38.10	25.40	22.23	11.11	26.85	30.25	53.70	57.10	5.6	35.0	48.9	19,500(191.2)	3,400(33.34)	6.28	80
KCM 120HE-2					51.30	54.70	102.60	106.00				39,000(382.5)	5,780(55.68)	12.45	
KCM 140HE	44.45	25.40	25.40	12.71	28.95	32.95	57.90	61.90	6.4	40.7	52.2	25,000(250.1)	4,500(44.13)	7.83	68
KCM 140HE-2					55.05	59.05	110.10	114.10				51,000(500.1)	7,650(75.02)	15.50	34

NOTES: • Connecting links of KCM 40H to KCM 60H are clip type.
 • Single strand chain can be used with KCM standard sprocket.
 • Multiple strand chain is separately manufactured because center-to-center



This chain uses hollow pins to which various attachments can easily be fixed. Nickel plated version and stainless steel version are available. Standard and double pitch chains are available.

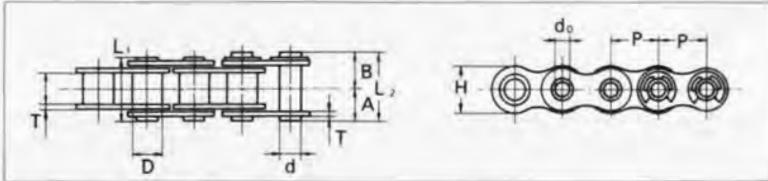

Roller Chain Type



Dimensions (millimeters)

KCM Chain Number	Pitch P	Width between inner plates W	Bush diameter D	Pin						Link plate		Average Tensile strength kgf (kN)	Maximum Allowable Load kgf (kN)	Approx weight (kg/m)	Links of 1 unit
				Diameter d	d ₀	A	B	(A+A) L ₁	(A+B) L ₂	Thickness T	Height H				
KCM 40 HP	12.70	7.95	7.95	5.68	4.00	8.1	9.4	16.2	17.5	1.5	11.7	1,350 (13.2)	180 (1.77)	0.51	240
KCM 50 HP	15.875	9.53	10.16	7.24	5.12	10.3	11.7	20.6	22.0	2.0	14.6	2,100 (20.6)	320 (3.14)	0.83	192
KCM 60 HP	19.05	12.70	11.91	8.37	5.99	12.9	14.3	25.8	27.2	2.4	17.5	3,200 (31.4)	430 (4.22)	1.24	160
KCM 80 HP	25.40	15.88	15.88	11.24	8.02	16.3	17.8	32.6	34.1	3.2	23.0	5,400 (53.0)	780 (7.65)	2.32	120

Double Pitch Chain Type S-roller Type (bushed)



R-roller Type

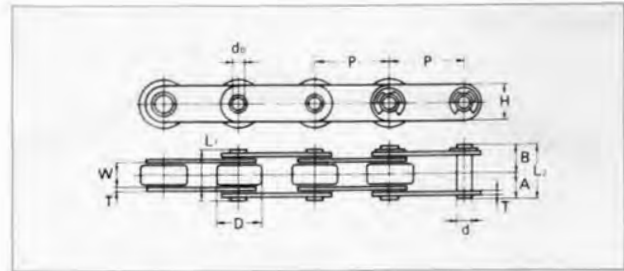
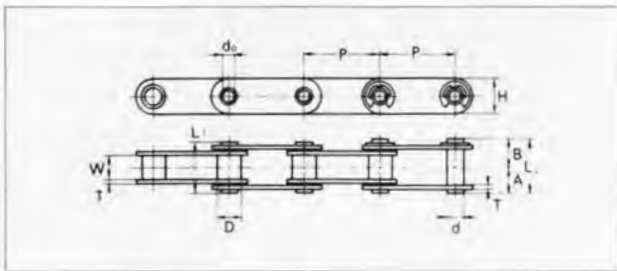

Dimensions (millimeters)

KCM Chain Number	Pitch P	Width between inner plates W	Roller diameter D	Pin						Link plate		Average Tensile strength kgf (kN)	Maximum Allowable Load kgf (kN)	Approx weight (kg/m)	Links of 1 unit
				Diameter d	d ₀	A	B	(A+A) L ₁	(A+B) L ₂	Thickness T	Height H				
KCM C2040 HP	25.40	7.95	* 7.95	5.68	4.00	8.1	9.4	16.2	17.5	1.5	11.7	1,350 (13.2)	180 (1.77)	0.46	120
KCM C2042 HP			15.88											0.80	
KCM C2050 HP			* 10.16	7.24	5.12	10.3	11.7	20.6	22.0	2.0	14.6	2,100 (20.6)	320 (3.14)	0.76	96
KCM C2052 HP	31.75	9.53	19.05											1.25	
KCM C2060 HP			* 11.91	8.37	5.99	12.9	14.3	25.8	27.2	2.4	17.5	3,200 (31.4)	430 (4.22)	1.12	80
KCM C2062 HP	38.10	12.70	22.23											1.79	
KCM C2080 HP			* 15.88	11.24	8.02	16.3	17.8	32.6	34.1	3.2	23.0	5,400 (53.0)	780 (7.65)	1.98	60
KCM C2082 HP	50.80	15.88	28.58											3.17	

Leaf Chain Selection



Leaf chain, also called a balance chain, features a simple steel structure consisting of plates and pins. This chain is used for load lifting and balancing. Application (For Example: Fork Lifts)

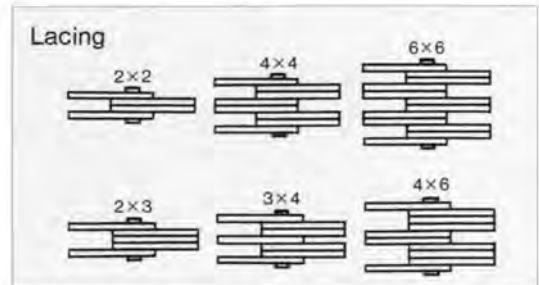

Type

Leaf chain falls into two types: AL type for light loading and BL type for heavy loading. AL type is used for applications without impact and with daily repetition of 100 times or less.

Selection

1. Determine the following items according to operating conditions.

- Chain speed
- Daily repetition of power applications
- Working load (attachment weight, inertia force and impact force)

2. Determine chain type.

- U BL type is recommended
- Use roller chain if speed exceeds 30 m/min or number of daily repetition exceeds 1000.

3. Determine chain size by the following equation.

$$\text{Working load} \times \text{Use coefficient (Table 1)} \times \text{Safety factor (Table 2)} \leq \text{Min. tensile strength}$$

Table 1 Use Coefficient

Type of impact	Use	Use coefficient
Smooth transmission	Smooth starts and stops, and moderate load change (i.e., lowering of balance-weight)	1.0
Impact to some extent	Frequent starts, stops, load changes and operations (i.e., fork lift)	1.3
Impact	Rapid starts, stops, load changes and operations (i.e., mining and construction machinery)	1.5

Table 2 Safety Factor

	Plate combination No. repetition	Safety factor	
		2 x 2, 3 x 4	4 x 6
BL type	1000 times/day	8 or more	9 or more
	10 times/day	8 or more	9 or more
AL type	100 times/day	11 or more	12 or more

Notes to Selection

- Do not use a chain with low safety factor. Otherwise, pin will turn, resulting in chain failure.
- Perform periodic lubrication. Even when safety factor is satisfactory, insufficient lubrication will result in pin rotation.
- Safety factor of chain is determined by the related regulations, or by this bulletin, whichever is greater.

Attaching of Chains and Clevises

1. When clevis is outer link or connecting link:

Outer link connector and connecting link (standard) are used.

2. When clevis is inner link:

Inner link connector and connecting pin (with dimension "W") are used.

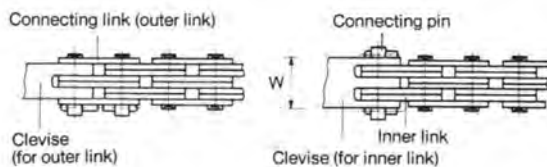

Sheave

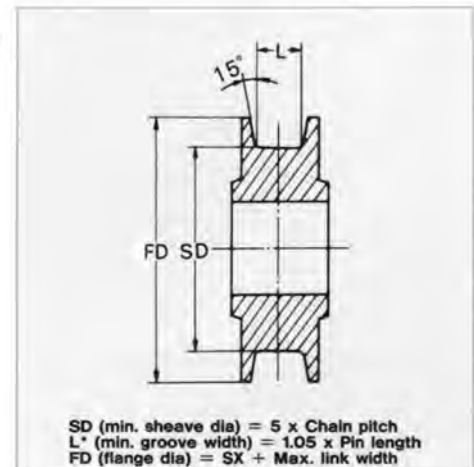

$$\begin{aligned} SD \text{ (min. sheave dia)} &= 5 \times \text{Chain pitch} \\ L^* \text{ (min. groove width)} &= 1.05 \times \text{Pin length} \\ FD \text{ (flange dia)} &= SX + \text{Max. link width} \end{aligned}$$

*Connecting pin cannot be engaged with sheave.

Leaf Chain Operating Notes

- Lubricate leaf chain periodically to avoid rotation of pin and reduce wear for extended service life.
 - Recommended oil: SAE30-SAE40
 - Lubrication intervals: Determined to keep lubricant left between pin inner link plate.
 - Lubrication method: Lubrication into keep space between link plates when chain is loosened.
- Avoid use of chain in corrosive environment.
- Measure chain length periodically to check for wear elongation.
 - If elongation reaches its limit (3%), immediately replace chain.

AL Series

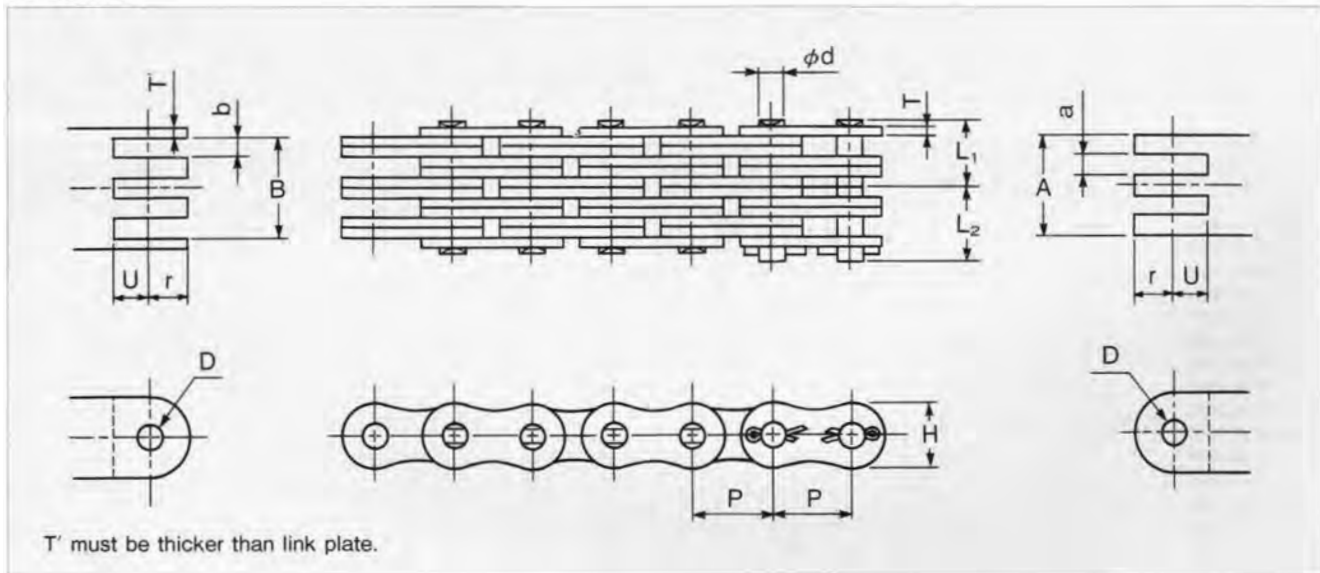

K.C.M chain No.	Pitch p	Plate			Pin			Min. tensile kN (kgf)	l-m chain (kg)	End connector						
		Lacing	Thins (Thickness) T	Width H	OD ϕd	Caulked L_1	Pinned L_2			D Min	r Max	U Min	A Max	a Min	B Min	b Min
KCM AL422	12.70	2 x 2	1.5	10.1	3.97	3.93	6.13	16.7(1,700)	0.34	4.00	6.35	5.72	3.04	—	—	3.39
KCM AL444		4 x 4				6.98	9.18	33.3(3,400)	0.68				9.47	9.82		
KCM AL466		6 x 6				10.05	12.25	50.0(5,100)	1.03				15.90	16.25		
KCM AL522	15.875	2 x 2	2.0	12.6	5.09	5.2	7.15	27.5(2,800)	0.61	5.12	7.94	7.14	4.03	—	—	4.44
KCM AL544		4 x 4				9.3	11.25	54.9(5,600)	1.18				12.50	12.91		
KCM AL566		6 x 6				13.4	15.35	82.4(8,400)	1.76				20.97	21.38		
KCM AL644	19.05	4 x 4	2.4	15.0	5.96	11.15	13.85	76.5(7,800)	1.70	5.98	9.53	8.56	14.69	5.23	15.19	5.23
KCM AL666		6 x 6				16.13	18.83	114.7(11,700)	2.53				24.65	25.15		
KCM AL844		4 x 4				14.43	17.53	129.4(13,200)	2.92				19.80	20.40		
KCM AL866	25.40	6 x 6	3.2	19.7	7.94	20.93	24.03	194.2(19,800)	4.35	7.96	12.70	11.43	33.20	7.00	33.30	7.00
KCM AL1044		4 x 4				18.6	21.55	196.1(20,000)	4.65				24.49	25.19		
KCM AL1066		6 x 6				26.8	29.75	294.2(30,000)	6.94				41.05	41.75		
KCM AL1244	38.10	4 x 4	4.8	30.0	11.11	22.1	25.5	282.4(28,000)	6.70	11.14	19.05	17.14	29.30	10.30	30.10	10.30
KCM AL1266		6 x 6				31.9	35.3	423.6(43,200)	9.99				49.10	49.90		
KCM AL1444		4 x 4				25.88	29.88	372.7(38,000)	9.48				34.46	35.38		
KCM AL1466	44.45	6 x 6	5.6	34.9	12.71	37.38	41.38	559.0(57,000)	14.17	12.74	22.23	20.02	57.74	12.10	58.66	12.10
KCM AL1644		4 x 4				29.55	34.25	470.7(48,000)	12.26				39.09	40.11		
KCM AL1666		6 x 6				42.75	47.45	706.1(72,000)	18.32				65.49	66.51		

NOTES:
 1. Dimension "U" excludes rounded area.
 2. It is required that end connector is made of alloy steel (SCM435, etc.), and properly heat-treated to hardness of HRC40-45.

Leaf Chain (BL Series)



BL Series

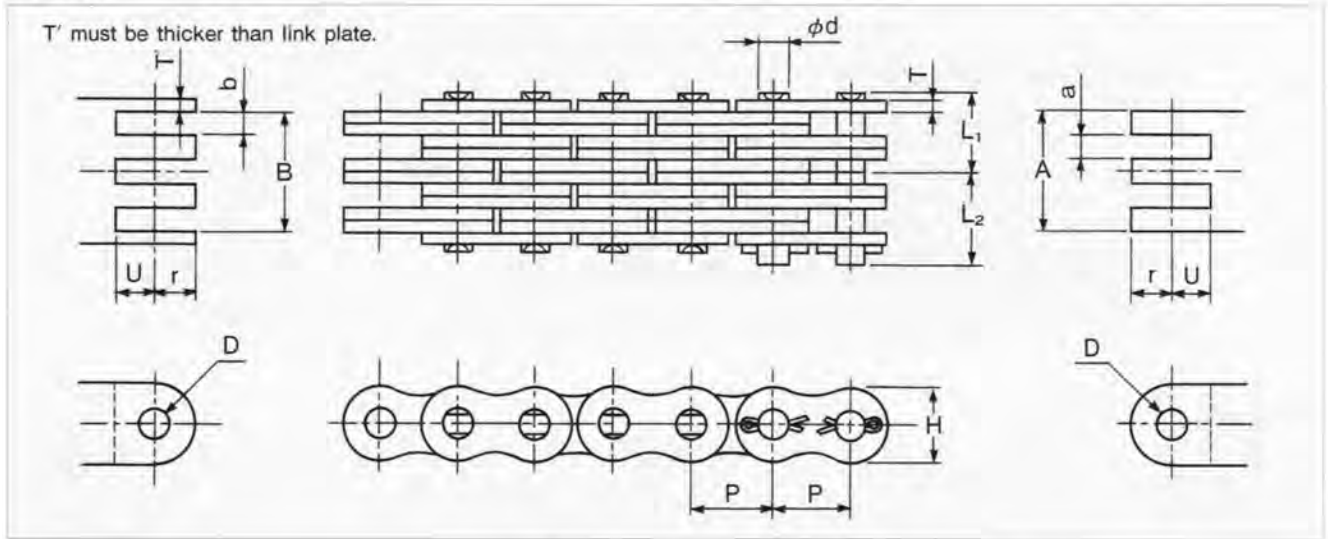

K.C.M chain No.	Pitch P	Plate		Pin			Min. tensile kN (kgf)	l-m chain (kg)	End connector							
		Lacing	Thickness T	Width H	OD φd	Caulked L ₁			Pinned L ₂	D Min	r Max	U Min	A Max	a Min	B Min	b Min
KCM BL422	12.7	2 x 2	2.0	11.7	5.09	5.20	7.15	23.50(2,400)	0.59	5.12	6.35	6.35	4.06	—	—	4.41
KCM BL423		2 x 3				6.22	8.18	23.50(2,400)	0.73				6.09	—	—	6.53
KCM BL434		3 x 4				8.27	10.23	35.30(3,600)	1.02				10.41	2.29	10.67	4.32
KCM BL444		4 x 4				9.30	11.25	47.10(4,800)	1.16				12.53	4.41	12.88	4.41
KCM BL446		4 x 6				11.35	13.30	47.10(4,800)	1.44				16.68	4.50	17.12	6.53
KCM BL466		6 x 6				13.40	15.35	70.60(7,200)	1.72				21.00	4.41	21.35	4.41
KCM BL522	15.875	2 x 2	2.4	14.6	5.96	6.20	8.90	39.20(4,000)	0.91	5.98	7.92	7.92	4.75	—	—	5.16
KCM BL523		2 x 3				7.42	10.13	39.20(4,000)	1.13				7.13	—	—	7.64
KCM BL534		3 x 4				9.90	12.60	58.80(6,000)	1.56				12.18	2.68	12.48	5.05
KCM BL544		4 x 4				11.15	13.85	78.50(8,000)	1.78				14.66	5.16	15.07	5.16
KCM BL546		4 x 6				13.62	16.33	78.50(8,000)	2.22				19.52	5.26	20.03	7.64
KCM BL566		6 x 6				16.10	18.80	117.70(12,000)	2.66				24.57	5.16	24.98	5.16
KCM BL622	19.05	2 x 2	3.2	17.5	7.94	7.92	11.03	63.70(6,500)	1.47	7.96	9.53	9.53	6.45	—	—	6.96
KCM BL623		2 x 3				9.55	12.65	63.70(6,500)	1.82				9.67	—	—	10.31
KCM BL634		3 x 4				12.80	15.90	95.60(9,750)	2.52				16.50	3.60	16.88	6.83
KCM BL644		4 x 4				14.42	17.53	127.50(13,000)	2.87				19.85	6.95	20.35	6.95
KCM BL646		4 x 6				17.67	20.78	127.50(13,000)	3.57				26.43	7.09	27.07	10.31
KCM BL666		6 x 6				20.92	24.03	191.20(19,500)	4.27				33.25	6.95	33.75	6.95
KCM BL822	25.4	2 x 2	4.0	23.0	9.54	10.40	13.35	103.00(10,500)	2.40	9.56	12.70	12.70	7.98	—	—	8.59
KCM BL823		2 x 3				12.45	15.40	103.00(10,500)	2.97				11.97	—	—	12.73
KCM BL834		3 x 4				16.55	19.50	154.90(15,800)	4.11				20.40	4.44	20.85	8.43
KCM BL844		4 x 4				18.60	21.55	205.90(21,000)	4.68				24.54	8.58	25.14	8.58
KCM BL846		4 x 6				22.70	25.65	205.90(21,000)	5.82				32.68	8.74	33.44	12.73
KCM BL866		6 x 6				26.80	29.75	308.90(31,500)	6.96				41.10	8.58	41.70	8.58
KCM BL1022	31.75	2 x 2	4.8	28.9	11.11	12.30	15.70	141.20(14,400)	3.56	11.14	15.88	15.88	9.55	—	—	10.26
KCM BL1023		2 x 3				14.75	18.15	141.20(14,400)	4.43				14.32	—	—	15.21
KCM BL1034		3 x 4				19.65	23.05	215.70(22,000)	6.17				24.40	5.30	24.93	10.08
KCM BL1044		4 x 4				22.10	25.50	282.40(28,800)	7.04				29.35	10.25	30.05	10.25
KCM BL1046		4 x 6				27.00	30.40	282.40(28,800)	8.78				39.07	10.43	39.95	15.20
KCM BL1066		6 x 6				31.90	35.30	423.60(43,200)	10.52				49.15	10.25	49.85	10.25
KCM BL1222	38.1	2 x 2	5.6	35.0	12.71	14.37	18.38	186.30(19,000)	5.15	12.74	19.05	19.05	11.24	—	—	12.05
KCM BL1223		2 x 3				17.25	21.25	186.30(19,000)	6.35				16.85	—	—	17.87
KCM BL1234		3 x 4				23.00	27.00	299.10(30,500)	8.71				28.70	6.22	29.30	11.84
KCM BL1244		4 x 4				25.87	29.88	372.70(38,000)	9.91				34.52	12.04	35.32	12.04
KCM BL1246		4 x 6				31.62	35.63	372.70(38,000)	12.37				45.96	12.26	46.98	17.87
KCM BL1266		6 x 6				37.37	41.38	559.00(57,000)	14.77				57.80	12.04	58.60	12.04
KCM BL1422	44.45	2 x 2	6.4	40.7	14.29	16.35	21.05	235.40(24,000)	6.69	14.31	22.23	22.23	12.74	—	—	13.66
KCM BL1423		2 x 3				19.65	24.35	235.40(24,000)	8.29				19.12	—	—	20.26
KCM BL1434		3 x 4				26.25	30.95	387.40(39,500)	11.50				32.54	7.06	33.23	13.43
KCM BL1444		4 x 4				29.55	34.25	470.70(48,000)	13.10				39.14	13.66	40.06	13.66
KCM BL1446		4 x 6				36.15	40.85	470.70(48,000)	16.40				52.12	13.88	53.26	20.26
KCM BL1466		6 x 6				42.75	47.45	706.10(72,000)	19.60				65.54	13.66	66.46	13.66

NOTES:

Semi-standard roller chain has narrower width (L1 and L2), and smaller size than those of standard type. The semi-standard is suited for use in limited space.

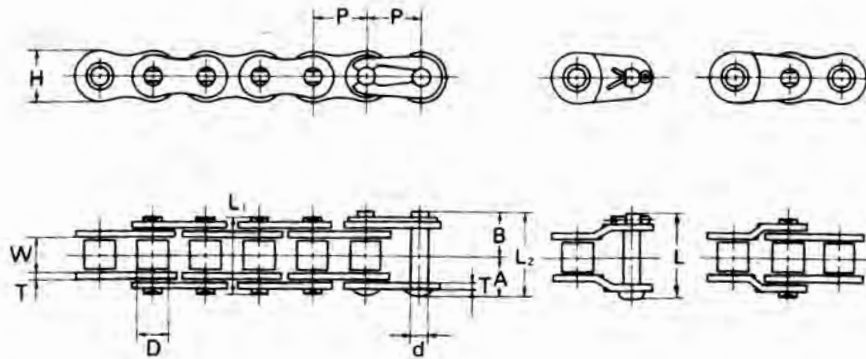

Dimensions (millimeters)

KCM Chain Number	Pitch P	Width between inner plates W	Roller diameter D	Pin					Link plate		Average Tensile strength kgf (kN)	Maximum Allowable Load kgf (kN)	Approx weight (kg/m)	Links of 1 unit	
				Diameter d	A	B	(A+A) L ₁	(A+B) L ₂	Offset L	Thickness T					Height H
KCM 415	12.70	4.76	7.75	3.64	5.50	6.90	11.00	12.40	12.95	1.1	9.5	1,000 (9.81)	220 (2.16)	0.34	240
KCM 415S	12.70	4.76	7.77	3.97	6.40	7.90	12.80	14.30	15.70	1.5	11.7	1,850 (18.14)	380 (3.73)	0.51	240
KCM 420	12.70	6.35	7.77	3.97	7.20	8.70	14.40	15.90	17.30	1.5	11.7	1,850 (18.14)	380 (3.73)	0.55	240
KCM 428	12.70	7.95	8.50	4.51	8.05	9.55	16.10	17.60	19.00	1.5	11.7	1,900 (18.63)	400 (3.92)	0.64	240
KCM 520	15.875	6.35	10.16	5.09	8.47	9.93	16.95	18.40	19.65	2.0	14.6	3,050 (29.91)	650 (6.37)	0.89	192
KCM 525	15.875	7.95	10.16	5.09	9.28	10.72	18.55	20.00	21.25	2.0	14.6	3,050 (29.91)	650 (6.37)	0.95	192
KCM 630	19.05	9.53	11.91	5.96	11.15	12.65	22.30	23.80	—	2.4	17.5	4,200 (41.19)	900 (8.83)	1.37	160

NOTES: - Use the exclusively designed sprocket.

The KCM motorcycle chains are developed to improve fatigue strength and wear resistance, and manufactures under stringent quality control.

Standard Type

Dimensions (millimeters)

KCM Chain Number	Pitch P	Width between inner plates W	Roller diameter D	Pin				Link plate		Average Tensile strength kgf (kN)	Maximum Allowable Load kgf (kN)	Approx weight (kg/m)
				Diameter d	B	L ₁	L ₂	Thickness T	Height H			
KCM 415 S	12.70	4.80	7.77	3.97	7.90	12.80	14.30	1.5	11.7	1,850 (18.1)	380 (3.73)	0.51
KCM 420	12.70	6.35	7.77	3.97	8.70	14.40	15.90	1.5	11.7	1,850 (18.1)	380 (3.73)	0.55
KCM 428	12.70	7.95	8.50	4.51	9.55	16.10	17.60	1.5	11.7	1,900 (18.6)	400 (3.92)	0.64
KCM 520	15.875	6.35	10.16	5.09	9.95	16.95	18.40	2.0	14.6	3,050 (29.9)	650 (6.37)	0.89
KCM 525	15.875	7.95	10.16	5.09	10.75	18.55	20.00	2.0	14.6	3,050 (29.9)	650 (6.37)	0.95
KCM 530	15.875	9.53	10.16	5.09	11.60	20.30	21.75	2.0	14.6	3,050 (29.9)	650 (6.37)	1.01
KCM 428H	12.70	7.95	8.50	4.51	10.55	18.10	19.60	2.0	11.7	2,300 (22.6)	450 (4.41)	0.77
KCM 520H	15.875	6.35	10.16	5.09	10.75	18.55	20.00	2.4	14.6	3,700 (36.3)	740 (7.26)	1.03
KCM 525H	15.875	7.95	10.16	5.09	11.55	20.15	21.60	2.4	14.6	3,700 (36.3)	740 (7.26)	1.07
KCM 530H	15.875	9.53	10.16	5.09	12.45	21.95	23.40	2.4	14.6	3,700 (36.3)	740 (7.26)	1.15

NOTE: Fatigue strength is not applied to joint.

Motorcycle Chain



KCM 410 and roller chains are mainly used for bicycles, but, teamed with special attachment, applicable to light-duty use such as for power transmission, transfer and relayed transmission in vending machines, etc.

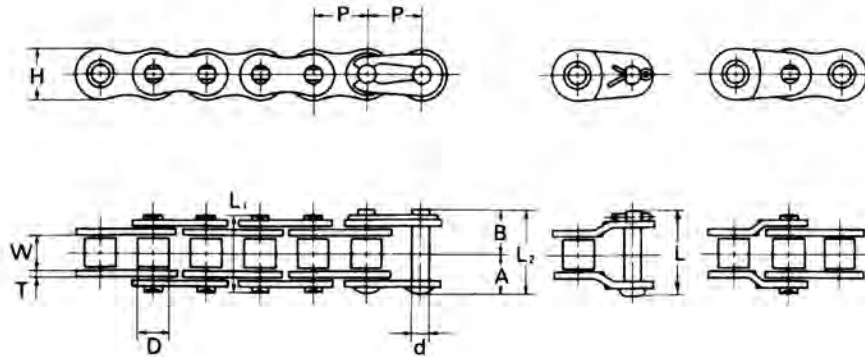

Dimensions (millimeters)

Chain Number		Pitch P	Width between inner plates W	Roller diameter D	Pin					Link plate		Average Tensile strength kgf (kN)	Approx. weight (kg/m)	
K.C.M.	JIS				Diameter d	A	B	(A+A) L ₁	(A+B) L ₂	Offset L	Thick- ness T			Height H
KCM 475	1/2 × 3/32		2.40	7.75	3.98	3.98	6.05	7.95	10.70	11.25	1.0	9.5	1,000 (9.81)	0.25
KCM 410	1/2 × 1/8	12.70	3.40	7.75	3.64	4.65	6.05	9.30	10.70	11.25	1.0	9.5	1,000 (9.81)	0.28

NOTE: KCM475 Connecting links and offset links are not available.

Maximum Allowable Loads of Surface-Treated Chains

KCM Chain No.	Max. Allowable Load of Surface-Treated Chain			Max. Allowable Load of SS Chains		Max. Allowable Load of Std SS Chains kgf (N)
	Rustop "N" kgf (N)	DC coat "DC" kgf (N)	BA coat "BA" kgf (N)	Standard "SS" kgf (N)	"AS" kgf (N)	
KCM 40	310 (3.04)	280 (2.75)	370 (3.63)	45 (0.44)	70 (0.69)	370 (3.63)
KCM 50	550 (5.39)	450 (4.41)	650 (6.37)	70 (0.69)	105 (1.03)	650 (6.37)
KCM 60	740 (7.26)	640 (6.28)	900 (8.83)	105 (1.03)	160 (1.57)	900 (8.83)
KCM 80	1,300 (12.70)	1,090 (10.69)	1,500 (14.71)	180 (1.77)	270 (2.65)	1,500 (14.71)
KCM 2040	280 (2.75)	280 (2.75)	280 (2.75)	45 (0.44)	70 (0.69)	280 (2.75)
KCM 2050	450 (4.41)	450 (4.41)	450 (4.41)	70 (0.69)	105 (1.03)	450 (4.41)
KCM 2060	640 (6.28)	640 (6.28)	640 (6.28)	105 (1.03)	160 (1.57)	640 (6.28)
KCM 2060H	640 (6.28)	640 (6.28)	640 (6.28)	105 (1.03)	160 (1.57)	640 (6.28)
KCM 2080	1,090 (10.69)	1,090 (10.69)	1,090 (10.69)	180 (1.77)	270 (2.65)	1,090 (10.69)
KCM 2080H	1,090 (10.69)	1,090 (10.69)	1,090 (10.69)	180 (1.77)	270 (2.65)	1,090 (10.69)

- NOTES:
1. Dimensions of surface-treated chains are the same as those of standard steel chains.
 2. Connecting links for DC coat chain are the same as those of standard steel chain.
 3. Connecting pins for BA coat chain are of split pin type.
 4. Surface-treated chain can be used in place of most standard, carbon steel chains and chains with attachments.

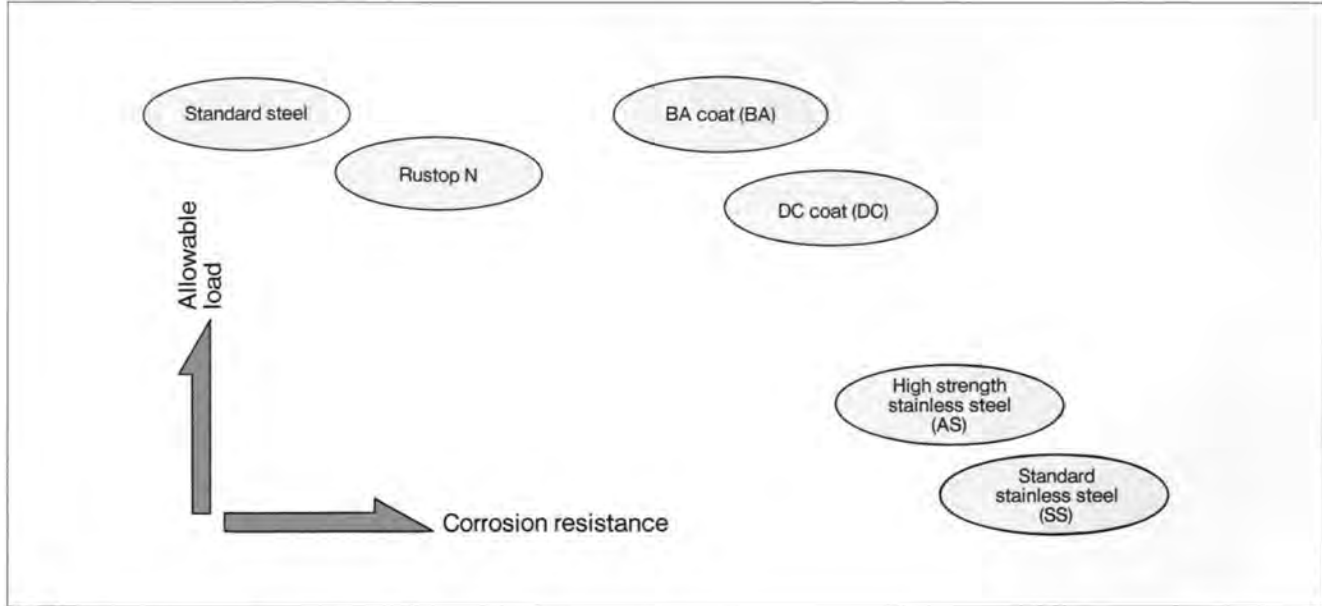

- NOTES:
1. This chart is graphical presentation, not showing actual ratios.
 2. Corrosion resistance varies depending on operating conditions.

SURFACE-TREATED CHAINS (N),(DC) and (BA)

These surface –treated chains have attractive appearance and increased corrosion resistance. Select the optimum type from the surface treated chains to suit your application .

Rustop: N

All parts are plated with special nickel.

- Attractive nickel-plated appearance and corrosion resistance
- Maximum allowable load: About 15 % lower than that of standard steel chain (see next page)
- Operating range: -10°C to $+60^{\circ}\text{C}$
- Usable instead of most steel chains and chains with attachments
- When ordering, please put a suffix "N" to chain No.

DC Coat (DC)

Special film is baked on surface. Matte silver white finish.

- Corrosion resistance second to stainless steel chain
- Usable even when subject to seawater
- Maximum allowable load: About 25% lower than that of standard steel chain (see next page)
- Even if protective film is peeled off, corrosion resistance is almost unaffected.
- Ordinary operating temperature range of -10°C to $+150^{\circ}\text{C}$ corrosion resistance of protective film is not changed until about 250°C .
- Usable instead of most steel chains and chains with attachments
- When ordering, please put a suffix "DC" to chain No.

BA Coat (BA)

Special mechanical surface treatment. Matte dark gray finish.

- Corrosion resistance superior to rustop chain (N).
- Usable even when subject to seawater
- Maximum allowable load is the same as that of standard steel chain (see next page)
- Protective film has higher peeling resistance than that of DC coat chain
- Ordinary operating temperature range of -10°C to $+150^{\circ}\text{C}$
- Usable instead of most steel chains and chains with attachments
- When ordering, please add suffix "BA" to chain No.

Safety Precautions: Do not use surface-treated chain if chain directly contacts food or abrasion particles are mixed into food.

The side bow may be curved for curved movement, using standard sprockets. Also, this chain can be used with attachments to from a curved conveyor, etc.

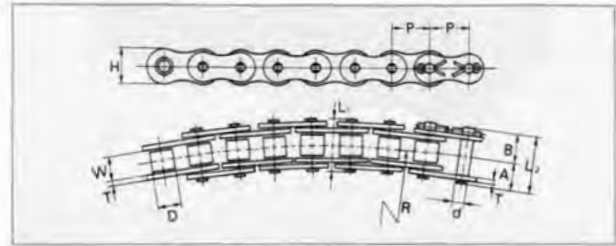

Dimensions (millimeters)

KCM Chain Number	Pitch P	Width between inner plates W	Roller diameter D	Pin				Link plate			Average Tensile strength kgf (kN)	Maximum Allowable Load kgf (kN)	Approx weight (kg/m)	
				Diameter d	A	B	(A+A) L ₁	(A+B) L ₂	Thickness T	Height H				R
KCM 40 SB	12.70	7.95	7.95	3.59	8.20	9.70	16.4	17.90	1.5	11.7	350	1,200(11.8)	190(1.86)	0.60
KCM 50 SB	15.875	9.53	10.16	4.51	10.35	12.30	20.7	22.65	2.0	14.6	400	2,100(20.6)	290(2.84)	0.98
KCM 60 SB	19.05	12.70	11.91	5.09	12.95	14.75	25.9	27.70	2.4	17.5	500	2,860(28.0)	410(4.02)	1.38
KCM 80 SB	25.40	15.88	15.88	5.96	16.40	18.60	32.8	35.30	3.2	23.0	600	4,000(39.2)	710(6.96)	2.53

Double Pitch Chain Type

S-roller Type

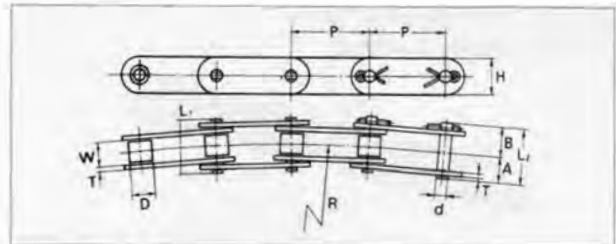

R-roller Type

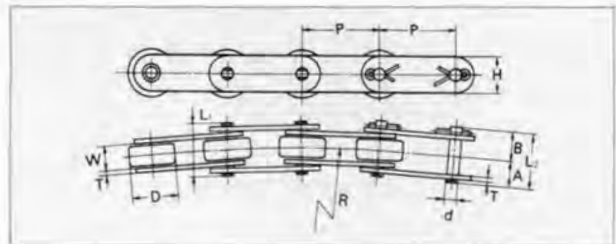

Dimensions (millimeters)

KCM Chain Number	Pitch P	Width between inner plates W	Roller diameter D	Pin				Link plate			Average Tensile strength kgf (kN)	Maximum Allowable Load kgf (kN)	Approx weight (kg/m)	
				Diameter d	A	B	(A+A) L ₁	(A+B) L ₂	Thickness T	Height H				R
KCM C2040 SB	25.40	7.95	7.95	3.59	8.20	9.70	16.4	17.90	1.5	11.7	700	1,200(11.8)	190(1.86)	0.45
KCM C2042 SB			15.88											0.77
KCM C2050 SB	31.75	9.53	10.16	4.51	10.35	12.30	20.7	22.65	2.0	14.6	800	2,100(20.6)	290(2.84)	0.74
KCM C2052 SB			19.05											1.21
KCM C2060 SB	38.10	12.70	11.91	5.09	12.95	14.75	25.9	27.70	2.4	17.5	1000	2,860(28.0)	410(4.02)	1.00
KCM C2062 SB			22.23											1.67
KCM C2080HSB	38.10	12.70	11.91	5.09	14.45	16.25	28.9	30.70	3.2	17.5	1000	2,860(28.0)	410(4.02)	1.29
KCM C2062HSB			22.23											1.96
KCM C2080 SB	50.80	15.88	15.88	5.96	16.40	18.90	32.8	35.3	3.2	23.0	1200	4,000(39.2)	710(6.96)	1.74
KCM C2082 SB			28.58											2.78
KCM C2080HSB	50.80	15.88	15.88	5.96	18.00	20.50	36.0	38.5	4.0	23.0	1200	4,000(39.2)	710(6.96)	2.17
KCM C2082HSB			28.58											3.21

Self Lubricating Chain

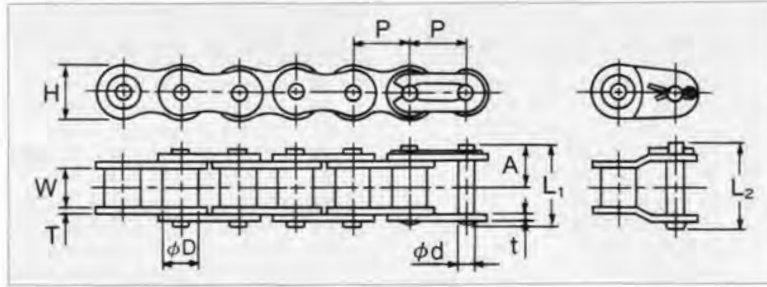

Dimensions (millimeters)

KCM Chain Number	Pitch P	Width between inner links W	Roller OD D	Pin			Link plate			Avg. breaking strength kgf (kN)	Max. allowable load kgf (kN)	Approx weight (kg/m)	Links of 1 unit	
				Diameter d	A	L ₁	L ₂	thkns T	Thkns t					Width H
KCM 40 SL	12.70	7.95	7.95	3.97	9.53	17.55	18.95	1.5	1.5	11.7	1,350(13.2)	230(2.25)	0.58	240
KCM 50 SL	15.875	9.53	10.16	5.09	11.60	21.75	23.00	2.0	2.0	14.6	2,100(20.6)	360(3.52)	0.97	192
KCM 60 SL	19.05	12.70	11.91	5.96	14.15	26.80	29.45	2.4	2.4	17.5	3,200(31.4)	540(5.28)	1.41	160
KCM 80 SL	25.40	15.88	15.88	7.94	19.18	35.25	36.90	3.2	3.2	23.0	5,350(52.5)	900(8.82)	2.40	120

NOTE: Connecting link of 80SL is of split pin type.

SL Double-Pitch Chain

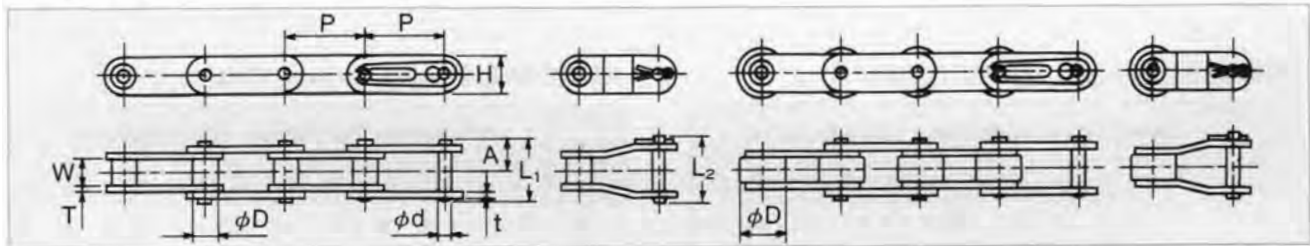

Dimensions (millimeters)

KCM Chain Number	Pitch P	Width between inner links W	Roller OD D	Pin			Link plate			Avg. breaking strength kgf (kN)	Max. allowable load kgf (kN)	Approx weight (kg/m)	Links of 1 unit	
				Diameter d	A	L ₁	L ₂	thkns T	Thkns t					Width H
KCM C2040 SL	25.40	7.95	7.95	3.96	9.53	17.55	18.95	1.5	1.5	11.7	1,350(13.2)	230(2.25)	0.49	120
KCM C2042 SL			15.88										0.77	
KCM C2050 SL	31.75	9.53	10.16	5.09	11.60	21.75	23.00	2.0	2.0	14.6	2,100(20.6)	360(3.52)	0.80	96
KCM C2052 SL			19.05										1.21	
KCM C2060 SL	38.10	12.70	11.91	5.96	14.15	26.80	29.45	2.4	2.4	17.5	3,200(31.4)	540(5.28)	1.18	80
KCM C2062 SL			22.23										1.76	
KCM C2080 SL	50.80	15.88	15.88	7.94	19.18	35.25	36.90	3.2	3.2	23.0	5,350(52.5)	900(8.82)	2.00	60
KCM C2082 SL			28.58										3.04	

NOTE: Connecting pins of C2080SL and C2082 are of split pin type.

Operating Notes to NL and SL Chains

- In dusty environment, there is a possibility that premature wear can occur. If the chain is exposed to water, oil impregnated in bushing, will come out, thus promoting wear.
- If oil comes out completely from bushing, rapid wear is caused, shortening service life.

All KCM stainless steel (ss) chains are made of SUS304 (18 CR/8 Ni) austenite steel for use in operating environment requiring high thermal resistance (-20°C to 400°C), corrosion resistance and cleanliness. They can also be fitted with attachments for conveying purpose.

Note: SUS304 stainless steel is almost non-magnetic, which is almost nil magnetic property equivalent to that of the air. The KCM stainless steel roller chains have slight magnetic property as a result of cold manufacturing.

The chains made of martensite and precipitation hardening stainless steel are available too.

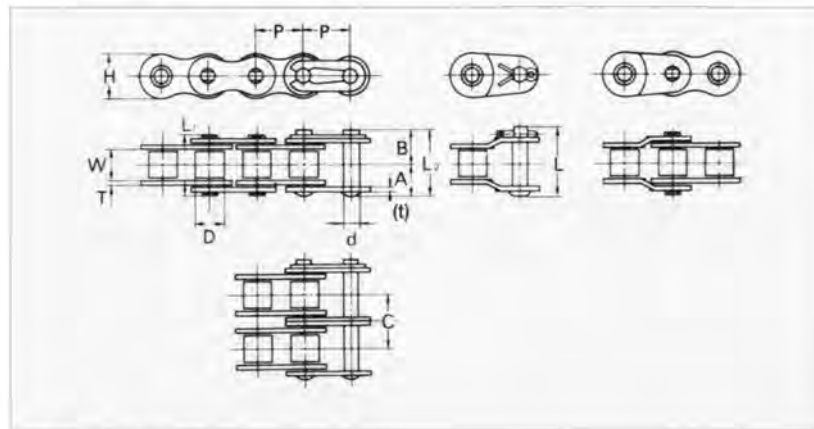

JIS B1801 Stainless Roller Chains

Dimensions (millimeters)

KCM Chain Number	Pitch p	Width between inner plates W	Roller diameter D	Pin					Link plate		Transverse pitch C	Maximum Allowable Load kgf (kN)	Approx weight (kg/m)	Links of 1 unit	
				Diameter d	A	B	(A+A) L ₁	(A+B) L ₂	Offset L	Thickness T					Height H
KCM 25 SS KCM 25 SS-2	6.35	3.18	*3.30	2.31	3.82 7.03	4.83 8.02	7.65 14.05	8.65 15.05	—	0.75	5.8	6.4	12(0.12) 21(0.21)	0.14 0.26	480
KCM 35 SS KCM 35 SS-2	9.525	4.78	*5.08	3.59	5.77 10.82	7.28 12.33	11.55 21.65	13.05 23.15	13.85 23.95	1.25	8.8	10.1	27(0.26) 46(0.45)	0.33 0.65	320
KCM 40 SS KCM 40 SS-2	12.70	7.95	7.95	3.97	8.07 15.27	9.48 16.68	16.15 30.55	17.55 31.95	19.05 33.45	1.5	11.7	14.4	45(0.44) 77(0.76)	0.63 1.19	240
KCM 50 SS KCM 50 SS-2	15.875	9.53	10.16	5.09	10.17 19.22	11.63 20.68	20.35 38.45	21.80 39.90	23.05 41.15	2.0	14.6	18.1	70(0.69) 119(1.17)	1.04 2.01	192
KCM 60 SS KCM 60 SS-2	19.05	12.70	11.91	5.96	12.7 24.10	14.2 25.60	25.40 48.20	26.90 49.70	29.55 52.35	2.4	17.5	22.8	105(1.03) 179(1.76)	1.50 2.95	160
KCM 80 SS KCM 80 SS-2	25.40	15.88	15.88	7.94	16.15 30.80	19.25 33.90	32.30 61.60	35.40 64.70	37.10 66.40	3.2	23.0	29.3	180(1.77) 306(3.00)	2.62 5.12	120

NOTES: - Figures marked with * imply bush diameter.
- For the KCM 25SS, only two-pitch offset links are available.
- For dimensions of the attachments, refer to pages 30 to 31.
- Links of the KCM 80SS use split pins.

ISO-B Stainless Roller Chains

Dimensions (millimeters)

KCM Chain Number	Pitch p	Width between inner plates W	Roller diameter D	Pin					Link plate		Transverse pitch C	Maximum Allowable Load kgf (kN)	Approx weight (kg/m)	Links of 1 unit	
				Diameter d	A	B	(A+A) L ₁	(A+B) L ₂	Offset L	Thickness T					Height H
KCM 04 SS	6.00	2.80	4.00	1.85	3.23	4.12	6.45	7.35	—	0.6	4.9	—	6(0.06)	0.11	834
KCM 05B SS KCM 05B SS-2	8.00	3.00	5.00	2.31	3.82 6.65	4.83 7.65	7.65 13.30	8.65 14.30	—	0.75	7.1	5.64	12(0.12) 21(0.21)	0.18 0.34	626
KCM 06B SS KCM 06B SS-2	9.525	5.72	6.35	3.28	6.1 11.22	7.6 12.73	12.20 22.45	13.70 23.95	15.15 25.40	1.3(1.0)	8.1	10.24	27(0.26) 46(0.45)	0.39 0.77	320
KCM 08B SS KCM 08B SS-2	12.70	7.75	8.51	4.45	8.17 15.12	9.58 16.53	16.35 30.25	17.75 31.65	19.30 33.20	1.5	11.7	13.92	45(0.44) 77(0.76)	0.65 1.25	240
KCM 10B SS KCM 10B SS-2	15.875	9.65	10.16	5.08	9.58 17.87	11.02 19.33	19.15 35.75	20.60 37.20	21.95 38.55	1.65	14.6	16.59	70(0.70) 119(1.17)	0.94 1.84	192
KCM 12B SS KCM 12B SS-2	19.05	11.68	12.07	5.72	11.05 20.77	12.55 22.28	22.10 41.55	23.60 43.05	26.30 45.75	1.8	16.0	19.46	105(1.00) 179(1.76)	1.25 2.44	160
KCM 16B SS KCM 16B SS-2	25.40	17.02	15.88	8.28	17.6 33.55	20.7 36.65	35.20 67.10	38.30 70.20	41.65 73.55	4.0(3.2)	19.7	31.88	180(1.77) 306(3.00)	2.63 5.19	120

NOTES: - 04SS, 05BSS offset link is 2-pitch type.
- Joint links of 16BSS is split pin type.

Stainless Steel Double Pitch Chain



Double-pitch Chains

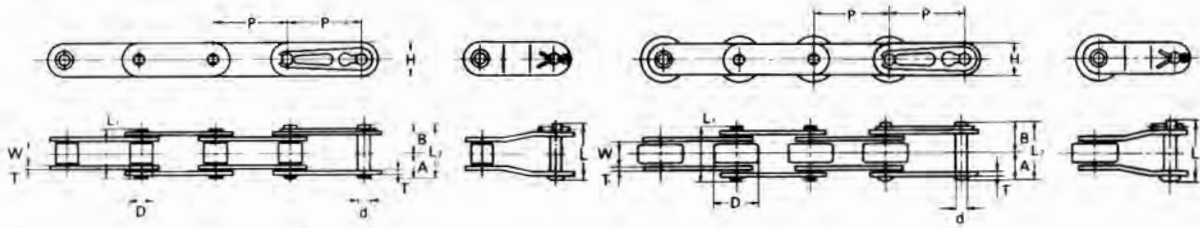

Double-pitch Roller Chains (for conveyor)

Dimensions (millimeters)

KCM Chain Number	Pitch P	Width between inner plates W	Roller diameter D	Pin						Link plate		Maximum Allowable Load kgf (kN)	Approx weight (kg/m)	Links of 1 unit
				Diameter d	A	B	(A+A) L ₁	(A+B) L ₂	Offset L	Thickness T	Height H			
KCM C2040 SS	25.40	7.95	7.95	3.97	8.07	10.28	16.15	18.35	19.05	1.5	11.7	45(0.44)	0.49	120
KCM C2042 SS			15.88											
KCM C2050 SS	31.75	9.53	10.16	5.09	10.17	12.13	20.35	22.30	23.05	2.0	14.6	70(0.69)	0.83	96
KCM C2052 SS			19.05											
KCM C2060 SS	38.10	12.70	11.91	5.96	12.70	15.40	25.40	28.10	29.55	2.4	17.5	105(1.03)	1.19	80
KCM C2062 SS			22.23											
KCM C2060H SS	38.10	12.70	11.91	5.96	14.35	17.05	28.76	31.40	32.85	3.2	17.5	105(1.03)	1.46	80
KCM C2062H SS			22.23											
KCM C2080 SS	50.80	15.88	15.88	7.94	16.15	19.25	32.30	35.40	37.16	3.2	23.0	180(1.77)	2.08	60
KCM C2082 SS			28.58											
KCM C2080H SS	50.80	15.88	15.88	7.94	17.80	20.90	35.60	38.70	40.40	4.0	23.0	180(1.77)	2.44	60
KCM C2082H SS			28.58											

NOTE: For dimensions of the attachments, refer to pages 32 to 33.

F-TYPE ROLLER CHAINS

The KCM F-type roller chains are standard roller chains using straight contour link plates, which are suitable for general power transmission, and conveying of materials placed directly on them.

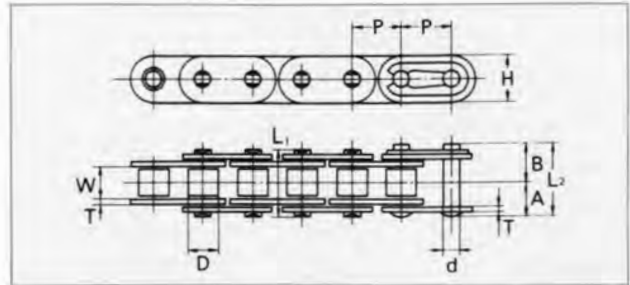

Dimensions (millimeters)

KCM Chain Number	Pitch P	Width between inner plates W	Roller diameter D	Pin					Link plate		Average Tensile strength kgf (kN)	Maximum Allowable Load kgf (kN)	Approx weight (kg/m)	Links of 1 unit
				Diameter d	A	B	(A+A) L ₁	(A+B) L ₂	Thickness T	Height H				
KCM 40 F	12.70	7.95	7.95	3.97	8.02	9.53	16.05	17.55	1.5	12.0	1,850(18.1)	370(3.63)	0.72	240
KCM 50 F	15.875	9.53	10.16	5.09	10.15	11.60	20.30	21.75	2.0	14.6	3,050(29.9)	650(6.37)	1.20	192
KCM 60 F	19.05	12.70	11.91	5.96	12.65	14.15	25.30	26.80	2.4	17.5	4,200(40.7)	900(8.83)	1.78	160
KCM 80 F	25.40	15.88	15.88	7.94	16.07	19.18	32.15	35.25	3.2	23.0	7,400(72.6)	1,500(14.71)	2.97	120
KCM 100 F	31.75	19.05	19.05	9.54	20.10	23.05	40.20	43.15	4.0	28.9	11,500(113.3)	2,300(22.56)	4.57	96
KCM 120 F	38.10	25.40	22.23	11.11	25.20	28.60	50.40	53.80	4.8	35.0	16,000(156.4)	3,100(30.40)	6.64	80

NOTES: - Offset links are not available.
- KCM standard sprockets are applicable.
- Boss diameter must be reduced to avoid interference with link plate.



A & CA TYPE ROLLER CHAINS

The KCM A and CA type roller chains are mainly employed for power transmission over relative long shaft-to-shaft distance and used with attachments, especially in large-sized farm machines.

A Type



CA Type

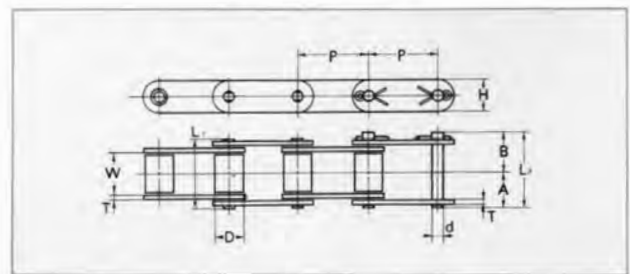
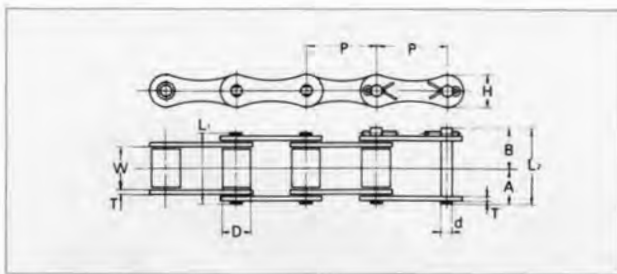

Dimensions (millimeters)

KCM Chain Number	Pitch P	Width between inner plates W	Roller diameter D	Pin					Link plate		Average Tensile strength kgf (kN)	Maximum Allowable Load kgf (kN)	Approx weight (kg/m)
				Diameter d	A	B	(A+A) L ₁	(A+B) L ₂	Thickness T	Height H			
KCM A550	41.40	20.40	16.66	7.13	17.0	20.55	34.0	37.55	2.6	19.0	4,350(42.7)	620(6.08)	1.59
KCM A620	42.01	25.20	17.68	7.13	20.5	24.05	41.0	44.55	3.1	19.0	5,200(51.0)	740(7.26)	1.98
KCM CA550	41.40	20.40	16.66	7.13	17.0	20.55	34.0	37.55	2.6	19.0	4,350(42.7)	620(6.08)	1.86
KCM CA557	41.40	20.40	17.78	8.00	18.7	21.55	37.4	40.25	3.1	22.0	6,200(60.8)	880(8.63)	2.41
KCM CA620	42.01	25.20	17.68	7.13	20.5	24.05	41.0	44.55	3.1	19.0	5,200(51.0)	740(7.26)	2.28

CAUTIONS (For Safe Operation)

- Always wear (proper) clothing and protective equipment (safety goggles and (proper) shoes) appropriate to the job.
- Pay attention to safety of work crew and surrounding workers.
- Follow the related labor safety regulations.
- Before starting the work, make sure to turn power off, and avoid accidental power-on. Also, be careful that clothing or part of body is not caught by a chain, sprocket, or peripheral equipment during work.
- Clean work area, and work in safe environment.
- Do not stand or walk under lifting equipment.
- Before transferring a chain, be sure to secure it firmly.

Adjusting Chain Length (Number of Links)

1. To shorten a chain to an appropriate length, use a proper jig, and employ a method appropriate to the structure of a chain.
It is recommended to use an exclusive jig.
2. To shorten a riveted chain, grind away riveted ends of a pair of rivets in the same link (on the same side).
3. Place a punch at ground end of a rivet, and strike a punch with a hammer. Be careful to hit two pins alternately.
If pin is withdrawn without grinding off riveted end, a chain will be damaged.
Grind away riveted ends.
4. After withdrawing pins, check to see if bushings are set correctly. If bushings are protruded, smooth power transmission cannot be achieved or strength of a chain is reduced.
5. Do not reuse the removed parts.

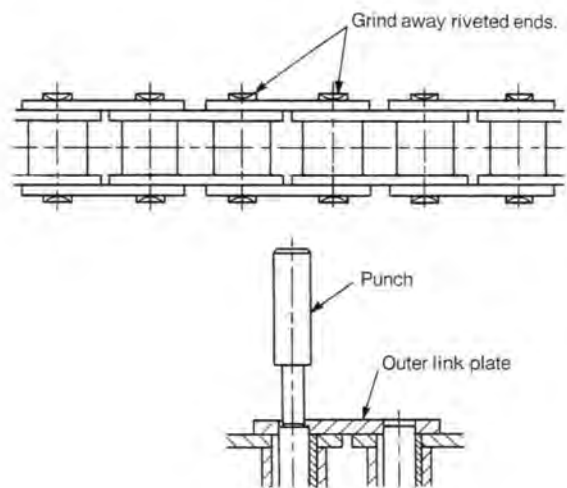

Connection (Installation to Equipment)

1. Confirm that sprocket shafts are parallel and level, and misalignment of sprockets is within tolerance.
2. Insert a connecting link between both ends (inner links) of a chain. In this case, this connection can be easily made when a chain is engaged with sprockets.
3. When inserting a connecting link, it is important that split pin hole or clip groove is exposed over a connecting link.
4. Install a split pin and clip.

- Open ends of split pin at 60° as shown.

- Install a clip in direction opposite to chain advancing.

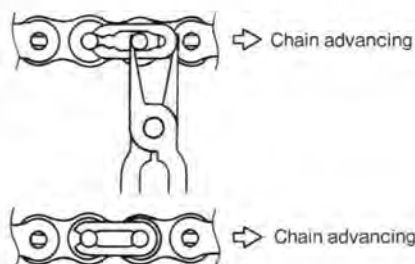
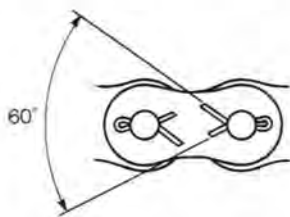

- Use genuine split pins or a clip.
- Note that connecting link will be disengaged in case of improper installation. Causing injury to people or equipment damage.

Proper slack "S" is determined by the following equation.

$$S = 0.02L$$

where, L is span

Adjust shaft-to-shaft distance to set proper slack "S".

In the following cases, determine slack "S" by the equation of $S \cong 0.01L$.

- Vertical arrangement
- Upper side of chain is slackened.
- Shaft-to-shaft distance exceeds 50 times pitch.
- Vibration or impact is present.
- Chain starts and stops frequently.
- Forward/reverse movements are repeated frequently.
- Speed change ratio exceeds 7:1.

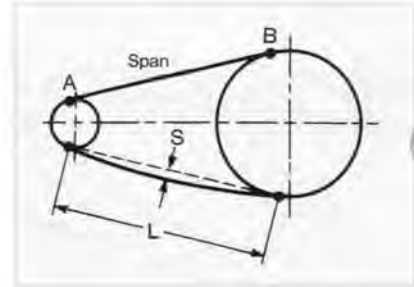

Proper shaft-to-shaft distance is 30 to 50 times pitch.



CAUTIONS (Remanufacturing and additional manufacturing are prohibited.)

- ⊘ Remanufacturing and additional manufacturing of chain and related parts are prohibited. Otherwise, this will lead to chain failure. If remanufacturing or additional manufacturing is necessary, contact us.
 - Electric plating will lead to brittle breakage.
 - Welding of heat-treated chain will cause cracks or sacrifice strength.
 - Annealing of heat-treated chain will reduce strength of part.
 - Enlargement of connecting link hole and reduction in connecting pin diameter will reduce strength.

2.Operation

Check Items Before Operation

- Before operation, check if the following items are correctly set and safety cover is installed.
- If abnormal noise is caused during operation, immediately stop operation, and find cause of trouble and remedy.

Check items	Description
Engagement	Check if sprocket is engaged correctly and slack is proper.
Link connection	Check if links are connected correctly and parts are firmly seated.
Interference	Check if there is any part or equipment that interferes with chain or any part that will be shattered.
Lubricant	Check if lubrication is proper.
Safety cover	Check if proper safety cover is installed.
Peripheral equipment	Check if peripheral equipment is installed.

Lubrication

Roller chain lubricated with oil or grease will splash at the start of operation. To avoid splashing of lubricant on clothing and skin, stand an appropriate distance away upon start up.

- Insufficient lubrication of chain will promote wear of pins and bushings due to dry friction. This will result in elongation of chain and poor performance of chain. To ensure service life of chain, choose the right lubricant and lubrication method to meet operating requirements. For correct chain selection when no lubrication is allowed, contact us or our dealer.

Lubricating Points:

- ① Clearances between inner and outer links (to avoid elongation of chain)
- ② Clearances between rollers and inner links (to reduce wear of bushings and rollers, to avoid their breakage, and to suppress noise)

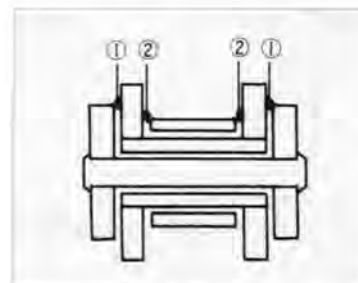

Inspection and maintenance are required to avoid trouble and keep power transmission ability.

Inspection Items and measures to Trouble

Inspection Items	Measures to Troubles
Harmful flaw or rust	Harmful flaw or rust will reduce strength. Early replacement is recommended.
Slack of chain	Adjust shaft-to-shaft distance if slack is improper. If it is found, by measuring of elongation, that service life of chain is expired, change chain
Rotation of pin (incorrect caulking position)	Possible cause is overloading. Review operating conditions. Do not use a chain with a bent pin.
Uneven wear of roller	Possible cause is poor rotation of rollers. Find cause of trouble. Change chain.
Insufficient movement of chain	Review power transmission conditions and lubrication method.
Lubrication of chain	Lubricate by correct lubrication method.

Elongation Measuring Method and Chain Replacement Timing

1. Measuring Chain Elongation

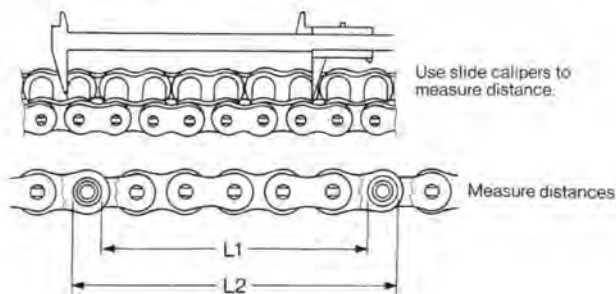

- Measure distances L1 and L2 with chain lightly loaded.
- Measure distance over 6 to 10 links to reduce measuring errors.
- Elongation of chain is determined by the following equation.

$$\text{Chain length} = \frac{L1 + L2}{2}$$

$$\text{Reference chain length} = \text{Pitch} \times \text{Number of links measured}$$

$$\text{Elongation (\%)} = \frac{\text{Chain length} - \text{Reference chain length}}{\text{Reference length}} \times 100$$

NOTE: Service life of chains varies depending on number of sprocket teeth, lubrication, operating environment, and other conditions, even though they are the same dimensions and type.

2. Chain Replacement Timing

Guideline for chain replacement, based on elongation of chain, is listed below.

Number of large sprocket teeth	Elongation (%)
60 or fewer	1.5
61 - 80	1.2
81 - 100	1.0
101 or more	0.8

- Listed data is applicable when take-up is possible, or when equipped with tensioner or idler.
- Shaft-to-shaft distance is fixed, guideline for elongation is 0.5% to 0.7%.
- When changing a chain, inspect sprockets.
Worn-out sprocket will adversely affect chain, performance.

CAUTIONS

1. Do not replace the damaged parts of a chain with new ones. In this case, change the whole chain. Also, do not install the used connecting link and parts to a new chain.
2. Do not adhere acid or alkaline liquid and highly volatile solvent to chain and sprockets, and do not use them for cleaning. If acid or alkaline liquid is accidentally adhered to chain, replace a chain with a new one. Adherence of acid or alkaline liquid will lead to brittle breakage. Use kerosene for cleaning. After cleaning, dry kerosene and apply lubricant sufficiently.

- Specifications in this bulletin are described, on condition of normal use in ordinary operating environment (-10°C to +60°C).
- For more details, contact us or our dealers.

Lubrication is of prime importance for roller chain, because it greatly influences its service life, especially in modern high-speed chain drivers. Therefore, the use of highly efficient lubrication is required.

Effect of lubrication

When lubricant is applied clearances among pin, bush and roller, oil film is formed to prevent wear on parts and serve as a cushion, and absorbs heat generated in chain.

Recommended lubricant is high-quality mineral oil.

Recommended Lubricants

Lubrication method	A · B				C				
	Temp (°C)	-10 ~ 0	0 ~ 40	40 ~ 50	50 ~ 60	-10 ~ 0	0 ~ 40	40 ~ 50	50 ~ 60
KCM chain NO.									
KCM25 ~ 50	SAE10W	SAE20W	SAE30	SAE40	SAE10W	SAE20W	SAE30	SAE40	SAE40
KCM60 ~ 80	SAE20W	SAE30	SAE40	SAE50					
KCM100									SAE20W
KCM120以上	SAE30	SAE40	SAE50						

Lubrication Methods (These also appear in Power Transmission Capacity tables)

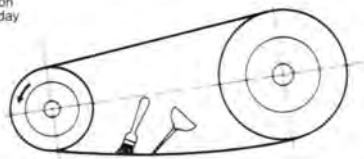
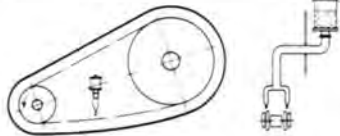
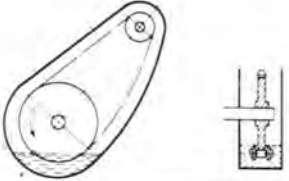
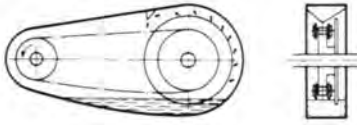
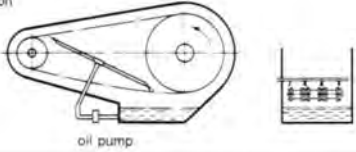
Lubrication method	Illustration	Lubrication intervals and Lubricant amount	Remarks
A	<p>Manual lubrication once a day</p> 	Periodic lubrication using oil feeder or brush, at least on full roller	Feed lubricant to chain while turning it slowly. Here, continuously apply oil 3 to 4 times on full roller chain length. Also, take care that your hand or cloth is not caught by chain drive. At start of lubrication, be careful that excessive oil will not splash.
	<p>Drip lubrication</p> 	Supply oil at 5 to 30 oil drops per minute.	It is recommended to provide simple casing against oil splash.
B	<p>Oil bath lubrication</p> 	Chain is submerged in oil at depth of 10mm.	Be careful to completely clean inside oil container before use to remove foreign matter such as dirt. Also, pay attention to oil temperature.
	<p>Rotating disc lubrication</p> 	Rotating disc splashes oil on roller chain. Disc submerging depth is about 20mm, and its circumferential speed is 200m/min or higher.	
C	<p>Forced circulation lubrication</p>  <p>oil pump</p>	It is required to maintain proper oil amount to avoid overheating.	Be careful to completely clean inside oil container before use to remove foreign matter such as dirt.